



SGM8142

350nA, Dual Rail-to-Rail I/O Operational Amplifier

GENERAL DESCRIPTION

The SGM8142 is a dual, high precision operational amplifier which can operate from 1.4V to 5.5V single supply, while consuming only 350nA/amplifier quiescent current. It provides rail-to-rail input and output operation. Therefore, the SGM8142 is suitable for use in portable instrumentation and battery-powered systems.

The SGM8142 is unity-gain stable, and features a 5kHz gain-bandwidth product. It is designed to provide optimal performance in low frequency systems, when monitoring battery current and conditioning sensor signal.

The SGM8142 is available in Green SOIC-8 and MSOP-8 packages. It operates over an ambient temperature range of -40°C to +85°C.

FEATURES

- **Low Quiescent Current: 350nA/Amplifier (TYP)**
- **Rail-to-Rail Input and Output**
- **Gain-Bandwidth Product: 5kHz at $V_s = 5V$ (TYP)**
- **Wide Supply Voltage Range: 1.4V to 5.5V**
- **Unity-Gain Stable**
- **-40°C to +85°C Operating Temperature Range**
- **Available in Green SOIC-8 and MSOP-8 Packages**

APPLICATIONS

Temperature Measurements
Toll Booth Tags
Battery-Powered Systems
Wearable Products

PACKAGE/ORDERING INFORMATION

MODEL	PACKAGE DESCRIPTION	SPECIFIED TEMPERATURE RANGE	ORDERING NUMBER	PACKAGE MARKING	PACKING OPTION
SGM8142	SOIC-8	-40°C to +85°C	SGM8142YS8G/TR	SGM8142YS8 XXXXX	Tape and Reel, 2500
	MSOP-8	-40°C to +85°C	SGM8142YMS8G/TR	SGM8142 YMS8 XXXXX	Tape and Reel, 3000

MARKING INFORMATION

NOTE: XXXXX = Date Code and Vendor Code.

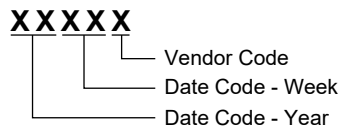

Green (RoHS & HSF): SG Micro Corp defines "Green" to mean Pb-Free (RoHS compatible) and free of halogen substances. If you have additional comments or questions, please contact your SGMICRO representative directly.

ABSOLUTE MAXIMUM RATINGS

- Supply Voltage 6V
- Analog Inputs (+IN, -IN) (-V_S) - 0.1V to (+V_S) + 0.1V
- Differential Input Voltage |(-V_S) - (+V_S)|
- Junction Temperature +150°C
- Storage Temperature Range -65°C to +150°C
- Lead Temperature (Soldering, 10s) +260°C
- ESD Susceptibility
- HBM 3000V
- MM 400V

can cause damage. ESD damage can range from subtle performance degradation to complete device failure. Precision integrated circuits may be more susceptible to damage because even small parametric changes could cause the device not to meet the published specifications.

RECOMMENDED OPERATING CONDITIONS

- Operating Temperature Range -40°C to +85°C

DISCLAIMER

SG Micro Corp reserves the right to make any change in circuit design, or specifications without prior notice.

OVERSTRESS CAUTION

Stresses beyond those listed in Absolute Maximum Ratings may cause permanent damage to the device. Exposure to absolute maximum rating conditions for extended periods may affect reliability. Functional operation of the device at any conditions beyond those indicated in the Recommended Operating Conditions section is not implied.

PIN CONFIGURATIONS

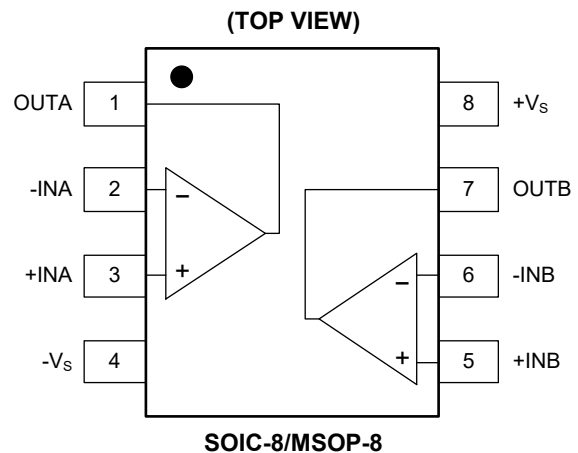

ESD SENSITIVITY CAUTION

This integrated circuit can be damaged if ESD protections are not considered carefully. SGMICRO recommends that all integrated circuits be handled with appropriate precautions. Failure to observe proper handling and installation procedures

ELECTRICAL CHARACTERISTICS(At $T_A = +25^\circ\text{C}$, $+V_S = 1.4\text{V}$ to 5.0V , $-V_S = \text{GND}$, $V_{\text{CM}} = +V_S/2$, $V_{\text{OUT}} \approx +V_S/2$ and $R_L = 1\text{M}\Omega$ to $+V_S/2$, unless otherwise noted.)

PARAMETER	SYMBOL	CONDITIONS	MIN	TYP	MAX	UNITS	
DC Electrical Characteristics							
Input Offset Voltage	V_{OS}	$V_{\text{CM}} = +V_S/2$		0.4	2.5	mV	
Input Offset Voltage Drift	$\Delta V_{\text{OS}}/\Delta T$	$V_{\text{CM}} = +V_S/2$, $-40^\circ\text{C} \leq T_A \leq +85^\circ\text{C}$		2		$\mu\text{V}/^\circ\text{C}$	
Power Supply Rejection Ratio	PSRR	$+V_S = 1.4\text{V}$ to 5.5V	69	80		dB	
Input Common Mode Voltage Range	V_{CMR}		$(-V_S) - 0.1$		$(+V_S) + 0.1$	V	
Common Mode Rejection Ratio	CMRR	$+V_S = 5.0\text{V}$, $V_{\text{CM}} = -0.1\text{V}$ to 5.1V	69	83		dB	
		$+V_S = 5.0\text{V}$, $V_{\text{CM}} = 2.5\text{V}$ to 5.1V	67	82			
		$+V_S = 5.0\text{V}$, $V_{\text{CM}} = -0.1\text{V}$ to 2.5V	63	77			
Large-Signal Voltage Gain	A_{VO}	$+V_S = 1.4\text{V}$, $R_L = 50\text{k}\Omega$, $V_{\text{OUT}} = (+V_S) - 0.1\text{V}$	75	80		dB	
		$+V_S = 2.5\text{V}$, $R_L = 50\text{k}\Omega$, $V_{\text{OUT}} = (+V_S) - 0.1\text{V}$		87			
		$+V_S = 5.0\text{V}$, $R_L = 50\text{k}\Omega$, $V_{\text{OUT}} = (+V_S) - 0.1\text{V}$	87	93			
Input Bias Current	I_{B}			1		pA	
Input Offset Current	I_{OS}			1		pA	
Maximum Output Voltage Swing	V_{OH}	$+V_S = 1.4\text{V}$, $R_L = 50\text{k}\Omega$	1.39	1.395		V	
		$+V_S = 2.5\text{V}$, $R_L = 50\text{k}\Omega$		2.497			
		$+V_S = 5.0\text{V}$, $R_L = 50\text{k}\Omega$	4.99	4.996			
	V_{OL}	$+V_S = 1.4\text{V}$, $R_L = 50\text{k}\Omega$			4.6	10	mV
		$+V_S = 2.5\text{V}$, $R_L = 50\text{k}\Omega$			3.1		
		$+V_S = 5.0\text{V}$, $R_L = 50\text{k}\Omega$			3.6	10	
Output Short-Circuit Current	I_{SC}	$+V_S = 2.5\text{V}$		5.6		mA	
		$+V_S = 5.0\text{V}$	22	24			
Supply Voltage	V_{CC}		1.4		5.5	V	
Quiescent Current/Amplifier	I_{Q}	$+V_S = 1.4\text{V}$		300		nA	
		$+V_S = 2.5\text{V}$		320			
		$+V_S = 5.0\text{V}$		350	800		

ELECTRICAL CHARACTERISTICS (continued)

(At $T_A = +25^\circ\text{C}$, $+V_S = 1.4\text{V}$ to 5.0V , $-V_S = \text{GND}$, $V_{\text{CM}} = +V_S/2$, $V_{\text{OUT}} \approx +V_S/2$ and $R_L = 1\text{M}\Omega$ to $+V_S/2$, $C_L = 60\text{pF}$, unless otherwise noted.)

PARAMETER	SYMBOL	CONDITIONS	MIN	TYP	MAX	UNITS
AC Electrical Characteristics						
Gain-Bandwidth Product	GBP	$+V_S = 1.4\text{V}$		4.3		kHz
		$+V_S = 2.5\text{V}$		4.7		
		$+V_S = 5.0\text{V}$		5		
Slew Rate	SR	$+V_S = 1.4\text{V}$, $V_{\text{OUT}} = 1\text{V Step}$		1.3		V/ms
		$+V_S = 2.5\text{V}$, $V_{\text{OUT}} = 1\text{V Step}$		1.5		
		$+V_S = 5.0\text{V}$, $V_{\text{OUT}} = 2\text{V Step}$		1.6		
Phase Margin	PM	$+V_S = 1.4\text{V}$ to 5.5V		60		$^\circ$
Input Voltage Noise	e_n p-p	$+V_S = 1.4\text{V}$, $f = 0.1\text{Hz}$ to 10Hz		4.4		$\mu\text{V}_{\text{P-P}}$
		$+V_S = 2.5\text{V}$, $f = 0.1\text{Hz}$ to 10Hz		3.9		
		$+V_S = 5.0\text{V}$, $f = 0.1\text{Hz}$ to 10Hz		4.0		
Input Voltage Noise Density	e_n	$+V_S = 1.4\text{V}$, $f = 1\text{kHz}$		135		$\text{nV}/\sqrt{\text{Hz}}$
		$+V_S = 2.5\text{V}$, $f = 1\text{kHz}$		140		
		$+V_S = 5.0\text{V}$, $f = 1\text{kHz}$		130		

TYPICAL PERFORMANCE CHARACTERISTICS

At $T_A = +25^\circ\text{C}$, $+V_S = 1.4\text{V}$ to 5.0V , $-V_S = \text{GND}$, $V_{CM} = +V_S/2$, $V_{OUT} \approx +V_S/2$ and $R_L = 1\text{M}\Omega$ to $+V_S/2$, $C_L = 60\text{pF}$, unless otherwise noted.

Large Signal Inverting Pulse Response

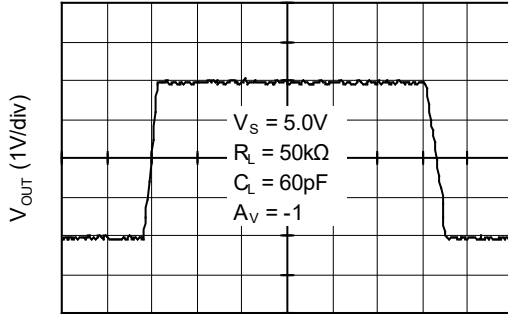

Time (5ms/div)

Large Signal Non-Inverting Pulse Response

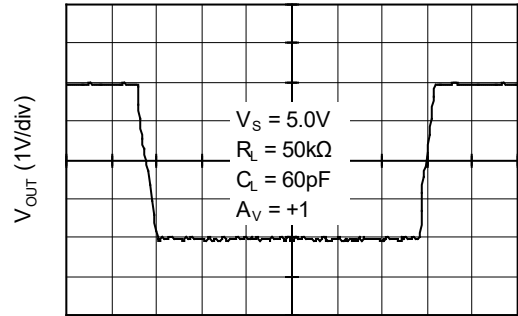

Time (5ms/div)

Small Signal Inverting Pulse Response

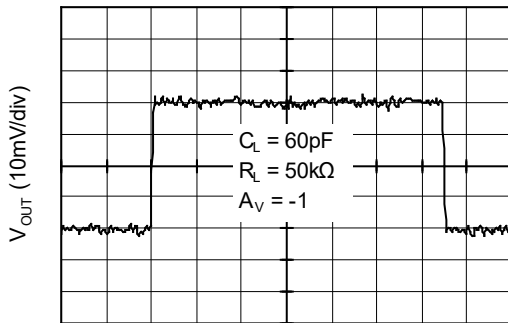

Time (5ms/div)

Small Signal Non-Inverting Pulse Response

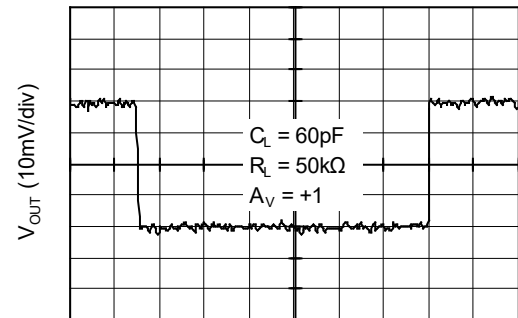

Time (5ms/div)

No Phase Reversal

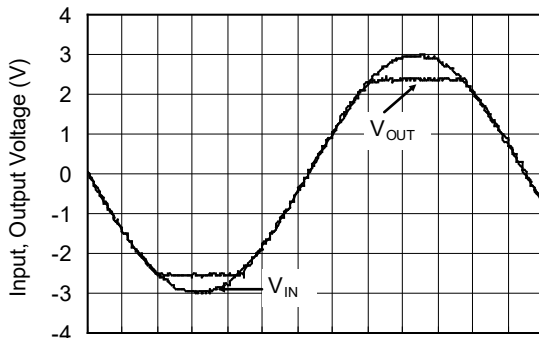

Time (5ms/div)

Slew Rate vs. Temperature

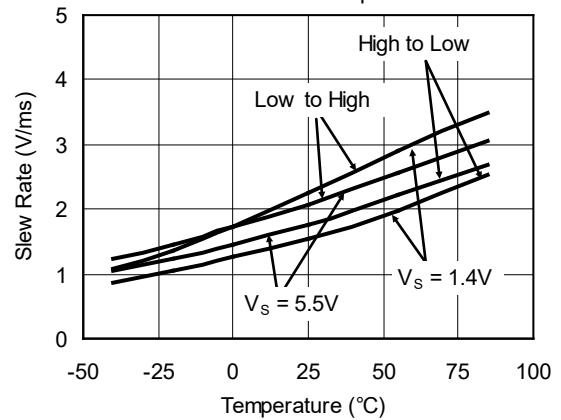

TYPICAL PERFORMANCE CHARACTERISTICS (continued)

At $T_A = +25^\circ\text{C}$, $+V_S = 1.4\text{V to } 5.0\text{V}$, $-V_S = \text{GND}$, $V_{CM} = +V_S/2$, $V_{OUT} \approx +V_S/2$ and $R_L = 1\text{M}\Omega$ to $+V_S/2$, $C_L = 60\text{pF}$, unless otherwise noted.

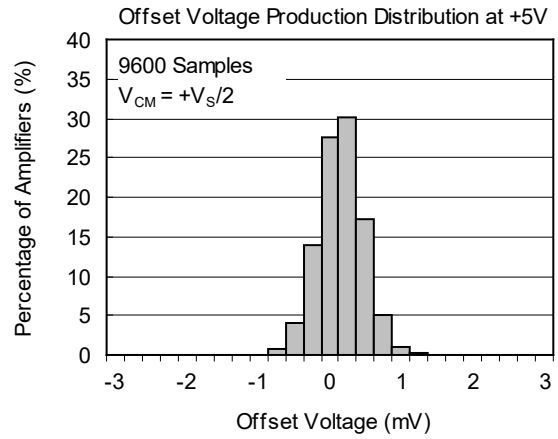
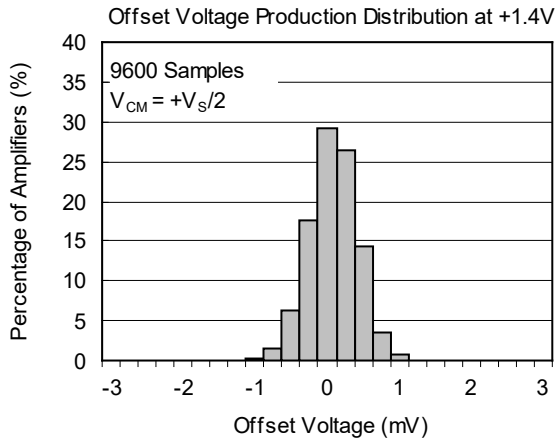

REVISION HISTORY

NOTE: Page numbers for previous revisions may differ from page numbers in the current version.

JANUARY 2013 – REV.A.1 to REV.A.2	Page
Added Tape and Reel Information section	9~10

MAY 2011 – REV.A to REV.A.1	Page
Updated Package Description	All

Changes from Original (APRIL 2010) to REV.A	Page
Changed from product preview to production data.....	All

PACKAGE OUTLINE DIMENSIONS

SOIC-8

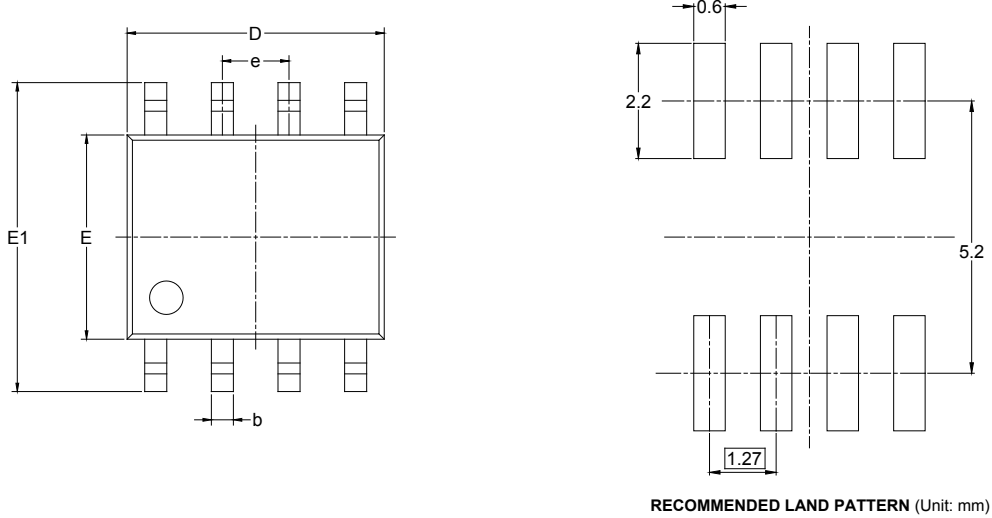

Symbol	Dimensions In Millimeters		Dimensions In Inches	
	MIN	MAX	MIN	MAX
A	1.350	1.750	0.053	0.069
A1	0.100	0.250	0.004	0.010
A2	1.350	1.550	0.053	0.061
b	0.330	0.510	0.013	0.020
c	0.170	0.250	0.006	0.010
D	4.700	5.100	0.185	0.200
E	3.800	4.000	0.150	0.157
E1	5.800	6.200	0.228	0.244
e	1.27 BSC		0.050 BSC	
L	0.400	1.270	0.016	0.050
θ	0°	8°	0°	8°

PACKAGE OUTLINE DIMENSIONS

MSOP-8



RECOMMENDED LAND PATTERN (Unit: mm)

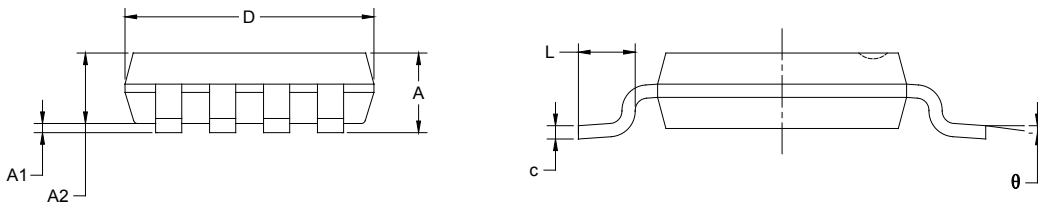

Symbol	Dimensions In Millimeters		Dimensions In Inches	
	MIN	MAX	MIN	MAX
A	0.820	1.100	0.032	0.043
A1	0.020	0.150	0.001	0.006
A2	0.750	0.950	0.030	0.037
b	0.250	0.380	0.010	0.015
c	0.090	0.230	0.004	0.009
D	2.900	3.100	0.114	0.122
E	2.900	3.100	0.114	0.122
E1	4.750	5.050	0.187	0.199
e	0.650 BSC		0.026 BSC	
L	0.400	0.800	0.016	0.031
θ	0°	6°	0°	6°

TAPE AND REEL INFORMATION

REEL DIMENSIONS



TAPE DIMENSIONS



NOTE: The picture is only for reference. Please make the object as the standard.

KEY PARAMETER LIST OF TAPE AND REEL

Package Type	Reel Diameter	Reel Width W1 (mm)	A0 (mm)	B0 (mm)	K0 (mm)	P0 (mm)	P1 (mm)	P2 (mm)	W (mm)	Pin1 Quadrant
SOIC-8	13"	12.4	6.40	5.40	2.10	4.0	8.0	2.0	12.0	Q1
MSOP-8	13"	12.4	5.20	3.30	1.50	4.0	8.0	2.0	12.0	Q1

DD0001

PACKAGE INFORMATION

CARTON BOX DIMENSIONS



NOTE: The picture is only for reference. Please make the object as the standard.

KEY PARAMETER LIST OF CARTON BOX

Reel Type	Length (mm)	Width (mm)	Height (mm)	Pizza/Carton
13"	386	280	370	5

DD0002