



# SGM3130

## 1MHz, 60 $\mu$ A, Rail-to-Rail I/O CMOS Operational Amplifier

### GENERAL DESCRIPTION

The SGM3130 (quad) is a low offset voltage, low power, voltage feedback amplifier. The device can operate from 2.1V to 5.5V single supply, while consuming only 60 $\mu$ A quiescent current per amplifier. It provides rail-to-rail input with a wide input common mode voltage range and rail-to-rail output voltage swing. This feature makes SGM3130 appropriate for buffering ASIC.

The SGM3130 offers a gain-bandwidth product of 1MHz and an ultra-low input bias current of 10pA. It is well suited for piezoelectric sensors, integrators and photodiode amplifiers.

The SGM3130 is designed into a wide range of applications, such as battery-powered instrumentation, safety monitoring, portable systems, and transducer interface circuits in low power systems.

The SGM3130 is available in a Green TQFN-3 $\times$ 3-16L package. It is specified over the extended -40 $^{\circ}$ C to +85 $^{\circ}$ C temperature range.

### FEATURES

- **Input Offset Voltage: 0.8mV (TYP)**
- **Ultra-Low Input Bias Current: 10pA**
- **Unity-Gain Stable**
- **Gain-Bandwidth Product: 1MHz**
- **Rail-to-Rail Input and Output**
- **Supply Voltage Range: 2.1V to 5.5V**
- **Input Voltage Range:**
  - 0.1V to 5.6V with  $V_S = 5.5V$
- **Low Supply Current: 60 $\mu$ A/Amplifier**
- **-40 $^{\circ}$ C to +85 $^{\circ}$ C Operating Temperature Range**
- **Available in a Green TQFN-3 $\times$ 3-16L Package**

### APPLICATIONS

ASIC Input or Output Amplifiers  
Piezoelectric Transducer Amplifiers  
Battery-Powered Equipment  
Portable Equipment  
Sensor Interfaces  
Medical Instrumentation  
Mobile Communications  
Audio Outputs  
Smoke Detectors  
Notebook PCs  
PCMCIA Cards  
DSP Interface

**PACKAGE/ORDERING INFORMATION**

MODEL	PACKAGE DESCRIPTION	SPECIFIED TEMPERATURE RANGE	ORDERING NUMBER	PACKAGE MARKING	PACKING OPTION
SGM3130	TQFN-3×3-16L	-40°C to +85°C	SGM3130YTQ16G/TR	3130TQ XXXXX	Tape and Reel, 3000

**MARKING INFORMATION**

NOTE: XXXXX = Date Code and Vendor Code.

**XXXXX**

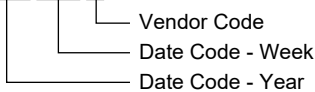

Green (RoHS & HSF): SG Micro Corp defines "Green" to mean Pb-Free (RoHS compatible) and free of halogen substances. If you have additional comments or questions, please contact your SGMICRO representative directly.

**ABSOLUTE MAXIMUM RATINGS**

- Supply Voltage, +V<sub>s</sub> to -V<sub>s</sub> ..... 6V
- Input Common Mode Voltage Range ..... (-V<sub>s</sub>) - 0.3V to (+V<sub>s</sub>) + 0.3V
- Junction Temperature ..... +150°C
- Storage Temperature Range ..... -65°C to +150°C
- Lead Temperature (Soldering, 10s) ..... +260°C
- ESD Susceptibility
- HBM ..... 4000V
- MM ..... 400V
- CDM ..... 1500V

performance degradation to complete device failure. Precision integrated circuits may be more susceptible to damage because even small parametric changes could cause the device not to meet the published specifications.

**DISCLAIMER**

SG Micro Corp reserves the right to make any change in circuit design, or specifications without prior notice.

**RECOMMENDED OPERATING CONDITIONS**

- Operating Temperature Range ..... -40°C to +85°C

**OVERSTRESS CAUTION**

Stresses beyond those listed in Absolute Maximum Ratings may cause permanent damage to the device. Exposure to absolute maximum rating conditions for extended periods may affect reliability. Functional operation of the device at any conditions beyond those indicated in the Recommended Operating Conditions section is not implied.

**ESD SENSITIVITY CAUTION**

This integrated circuit can be damaged if ESD protections are not considered carefully. SGMICRO recommends that all integrated circuits be handled with appropriate precautions. Failure to observe proper handling and installation procedures can cause damage. ESD damage can range from subtle

**PIN CONFIGURATION**

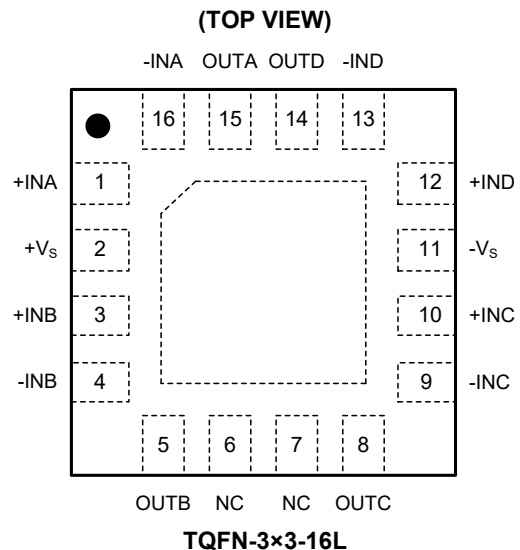

**ELECTRICAL CHARACTERISTICS**(At  $V_S = 5V$ ,  $R_L = 100k\Omega$  connected to  $V_S/2$ , and  $V_{OUT} = V_S/2$ , unless otherwise noted.)

PARAMETER	SYMBOL	CONDITIONS	SGM3130					
			TYP	MIN/MAX OVER TEMPERATURE			UNITS	MIN/MAX
			+25°C	+25°C	-40°C to +85°C			
<b>Input Characteristics</b>								
Input Offset Voltage	$V_{OS}$	$V_{CM} = V_S/2$	0.8	5	5.6	mV	MAX	
Input Bias Current	$I_B$		10			pA	TYP	
Input Offset Current	$I_{OS}$		10			pA	TYP	
Input Common Mode Voltage Range	$V_{CM}$	$V_S = 5.5V$	-0.1 to 5.6			V	TYP	
Common Mode Rejection Ratio	CMRR	$V_S = 5.5V, V_{CM} = -0.1V$ to 4V	70	62	62	dB	MIN	
		$V_S = 5.5V, V_{CM} = -0.1V$ to 5.6V	68	56	55			
Open-Loop Voltage Gain	$A_{OL}$	$R_L = 5k\Omega, V_{OUT} = 0.1V$ to 4.9V	80	70	70	dB	MIN	
		$R_L = 100k\Omega, V_{OUT} = 0.035V$ to 4.965V	84	80	80			
Input Offset Voltage Drift	$\Delta V_{OS}/\Delta T$		2.7			$\mu V/^\circ C$	TYP	
<b>Output Characteristics</b>								
Output Voltage Swing from Rail	$V_{OH}$	$R_L = 100k\Omega$	4.997	4.980	4.970	V	MIN	
	$V_{OL}$	$R_L = 100k\Omega$	5	20	30	mV	MAX	
	$V_{OH}$	$R_L = 10k\Omega$	4.992	4.970	4.960	V	MIN	
	$V_{OL}$	$R_L = 10k\Omega$	8	30	40	mV	MAX	
Output Current	$I_{SOURCE}$	$R_L = 10\Omega$ to $V_S/2$	84	50	35	mA	MIN	
	$I_{SINK}$		75	50	35			
<b>Power Supply</b>								
Operating Voltage Range				2.1	2.5	V	MIN	
				5.5	5.5	V	MAX	
Power Supply Rejection Ratio	PSRR	$V_S = 2.5V$ to 5.5V, $V_{CM} = 0.5V$	82	60	58	dB	MIN	
Quiescent Current/Amplifier	$I_Q$		60	80	86	$\mu A$	MAX	
<b>Dynamic Performance (<math>C_L = 100pF</math>)</b>								
Gain-Bandwidth Product	GBP		1			MHz	TYP	
Slew Rate	SR	$G = +1, 2V$ output step	0.52			V/ $\mu s$	TYP	
Settling Time to 0.1%	$t_s$	$G = +1, 2V$ output step	5.3			$\mu s$	TYP	
Overload Recovery Time		$V_{IN} \times G = V_S$	2.6			$\mu s$	TYP	
<b>Noise Performance</b>								
Voltage Noise Density	$e_n$	$f = 1kHz$	27			$nV/\sqrt{Hz}$	TYP	
		$f = 10kHz$	20			$nV/\sqrt{Hz}$	TYP	

TYPICAL PERFORMANCE CHARACTERISTICS

At  $T_A = +25^\circ\text{C}$ ,  $V_S = 5\text{V}$ , and  $R_L = 100\text{k}\Omega$  connected to  $V_S/2$ , unless otherwise noted.

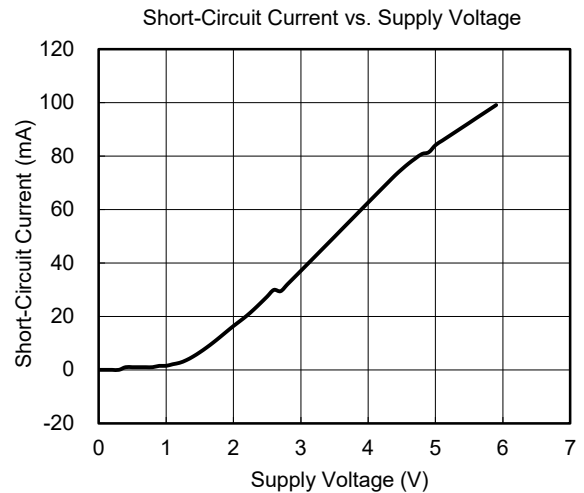
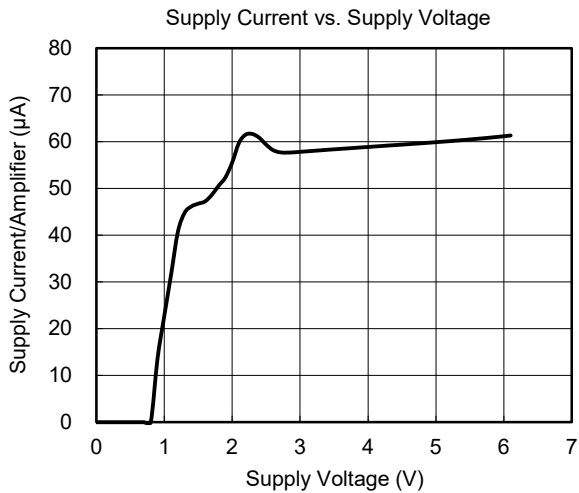
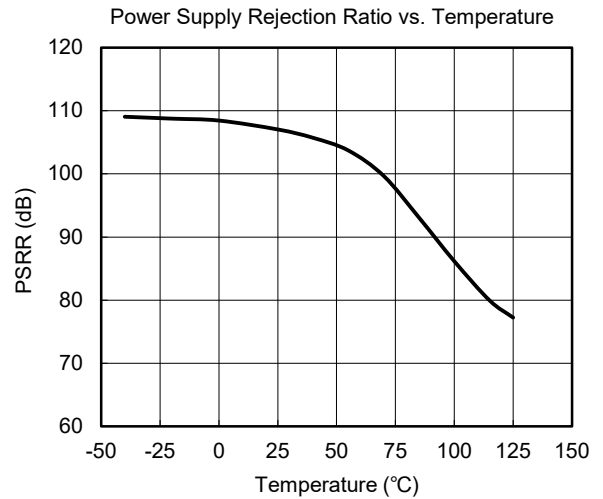
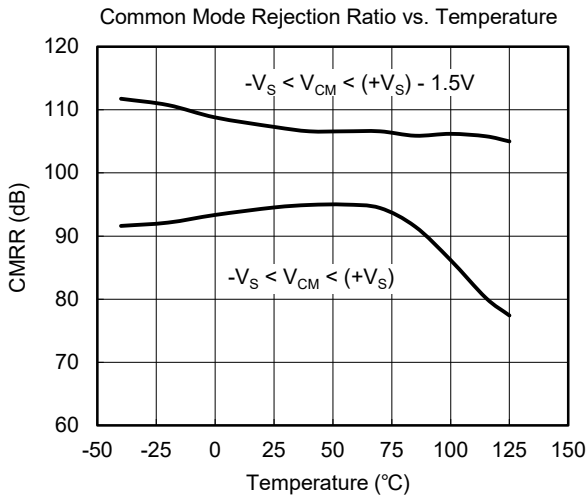
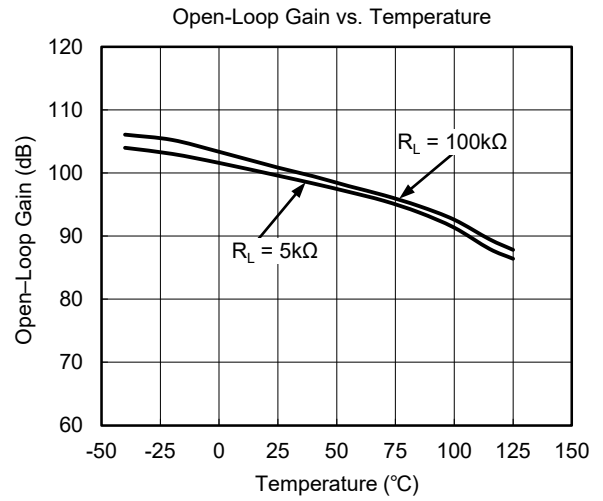
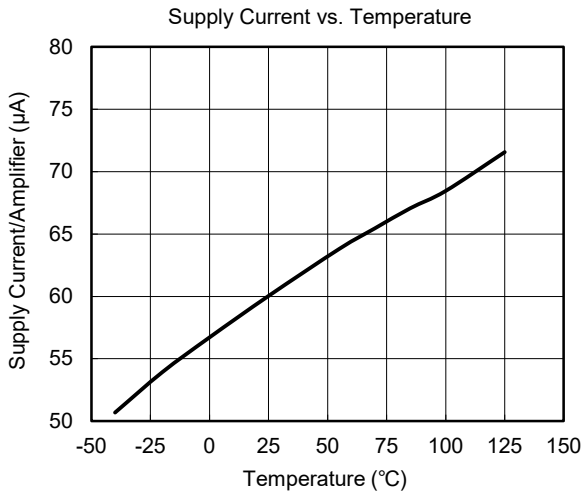

TYPICAL PERFORMANCE CHARACTERISTICS (continued)

At  $T_A = +25^\circ\text{C}$ ,  $V_S = 5\text{V}$ , and  $R_L = 100\text{k}\Omega$  connected to  $V_S/2$ , unless otherwise noted.

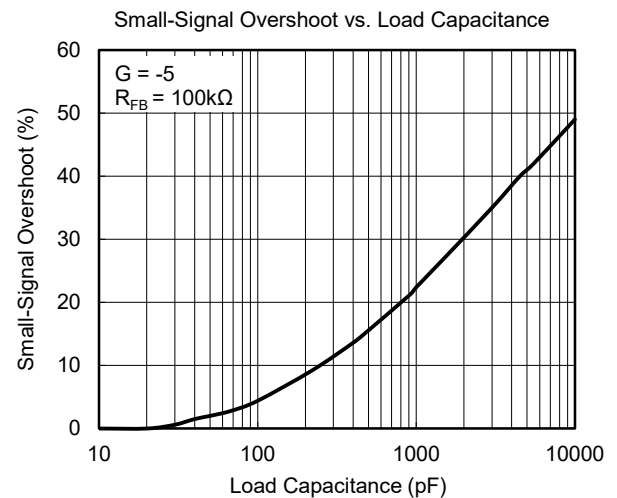
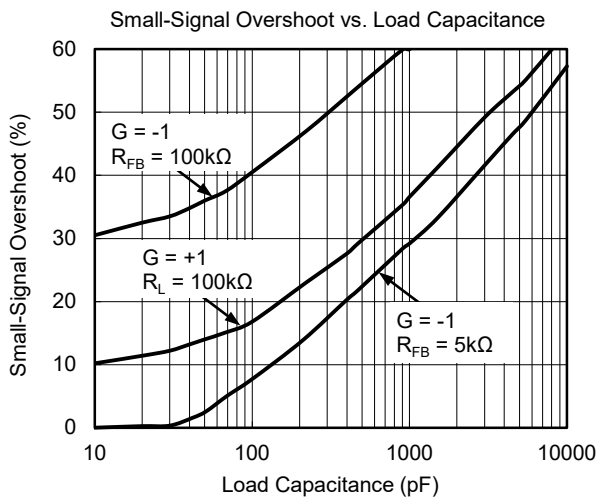
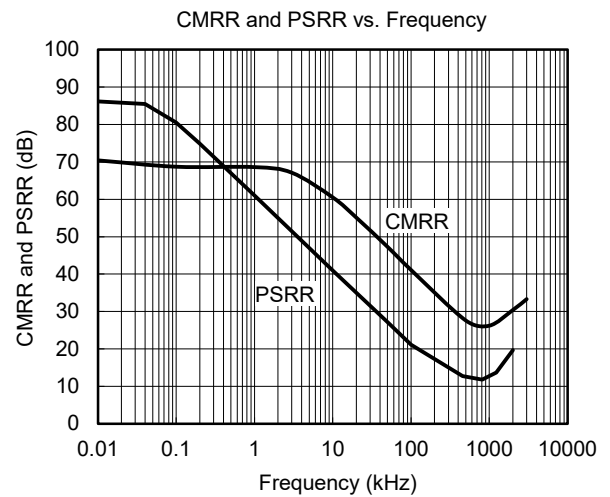
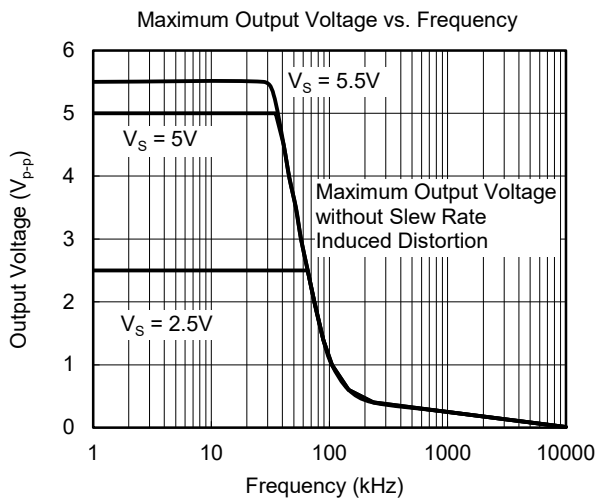
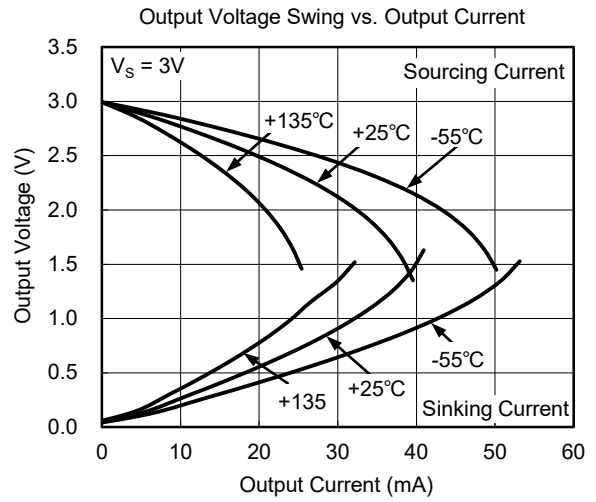
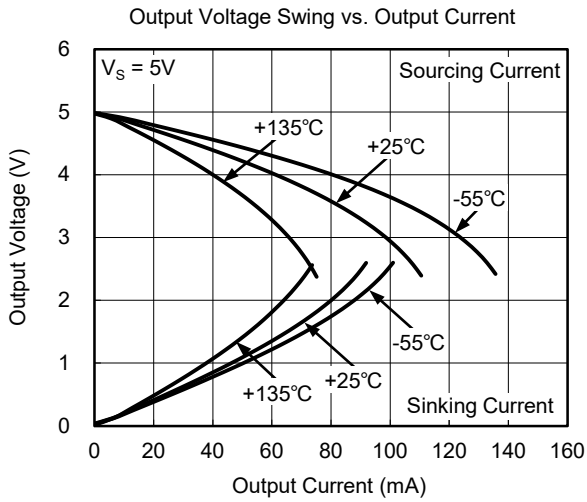

**TYPICAL PERFORMANCE CHARACTERISTICS (continued)**

At  $T_A = +25^\circ\text{C}$ ,  $V_S = 5\text{V}$ , and  $R_L = 100\text{k}\Omega$  connected to  $V_S/2$ , unless otherwise noted.

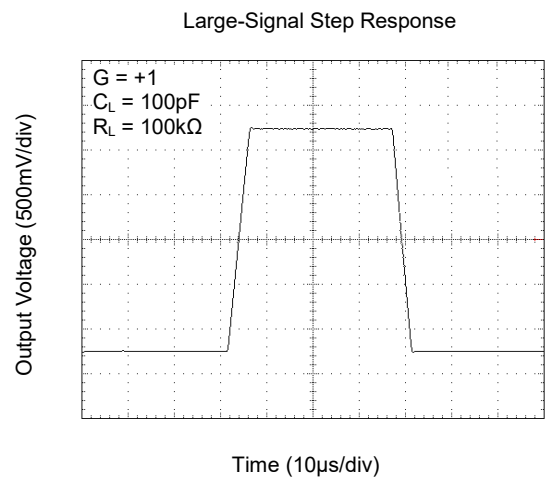
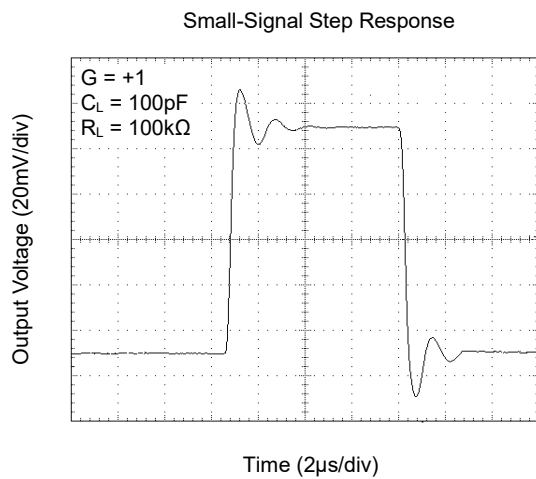
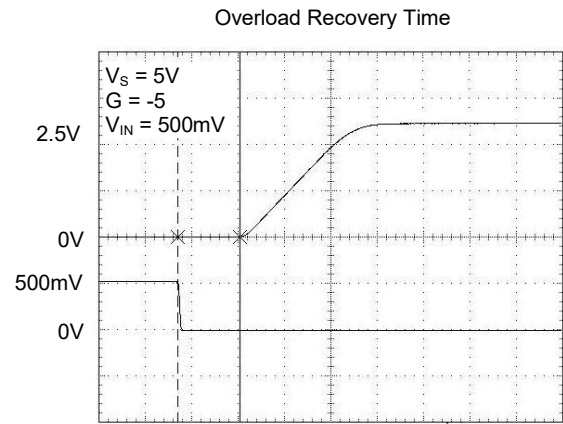
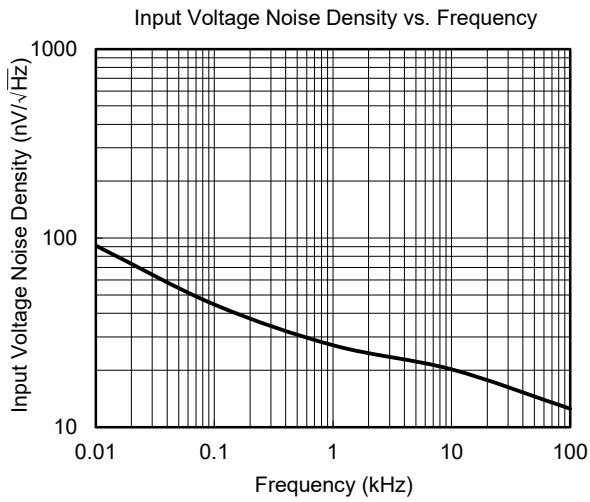

**REVISION HISTORY**

NOTE: Page numbers for previous revisions may differ from page numbers in the current version.

<b>MARCH 2021 – REV.A to REV.A.1</b>	<b>Page</b>
Updated Pin Configuration section.....	2

---

<b>Changes from Original (SEPTEMBER 2015) to REV.A</b>	<b>Page</b>
Changed from product preview to production data.....	All

---

# PACKAGE INFORMATION

## PACKAGE OUTLINE DIMENSIONS

### TQFN-3x3-16L

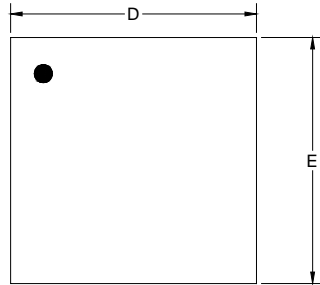

TOP VIEW

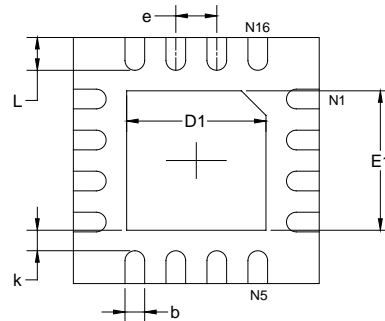

BOTTOM VIEW

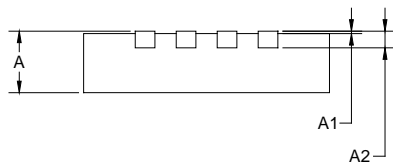

SIDE VIEW

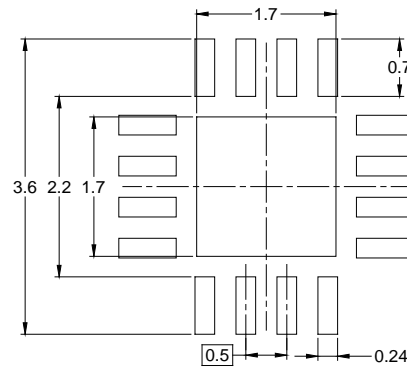

RECOMMENDED LAND PATTERN (Unit: mm)

Symbol	Dimensions In Millimeters		Dimensions In Inches	
	MIN	MAX	MIN	MAX
A	0.700	0.800	0.028	0.031
A1	0.000	0.050	0.000	0.002
A2	0.203 REF		0.008 REF	
D	2.900	3.100	0.114	0.122
D1	1.600	1.800	0.063	0.071
E	2.900	3.100	0.114	0.122
E1	1.600	1.800	0.063	0.071
k	0.200 MIN		0.008 MIN	
b	0.180	0.300	0.007	0.012
e	0.500 TYP		0.020 TYP	
L	0.300	0.500	0.012	0.020



# PACKAGE INFORMATION

## TAPE AND REEL INFORMATION

### REEL DIMENSIONS



### TAPE DIMENSIONS



NOTE: The picture is only for reference. Please make the object as the standard.

### KEY PARAMETER LIST OF TAPE AND REEL

Package Type	Reel Diameter	Reel Width W1 (mm)	A0 (mm)	B0 (mm)	K0 (mm)	P0 (mm)	P1 (mm)	P2 (mm)	W (mm)	Pin1 Quadrant
TQFN-3×3-16L	13"	12.4	3.35	3.35	1.13	4.0	8.0	2.0	12.0	Q1

DD0001

# PACKAGE INFORMATION

## CARTON BOX DIMENSIONS



NOTE: The picture is only for reference. Please make the object as the standard.

## KEY PARAMETER LIST OF CARTON BOX

Reel Type	Length (mm)	Width (mm)	Height (mm)	Pizza/Carton
13"	386	280	370	5

DD0002