



SGM8049-1/SGM8049-2/SGM8049-4

Low Voltage, Low Power, Rail-to-Rail I/O Operational Amplifiers

GENERAL DESCRIPTION

The SGM8049-1 (single), SGM8049-2 (dual) and SGM8049-4 (quad) are low voltage and micro-power operational amplifiers suitable for battery-powered systems. These devices can operate from 1.8V to 5.5V single supply, while consuming only 2.5 μ A/Amplifier quiescent current. They also provide rail-to-rail input and output operation.

The SGM8049-1/2/4 provide low power, low bias current and low noise. These devices fit in small packages. The combination of above features makes them appropriate for various applications.

The SGM8049-1 is available in Green SC70-5, SOT-23-5 and TDFN-2 \times 2-6L packages. The SGM8049-2 is available in Green SOT-23-8 and SOIC-8 packages. The SGM8049-4 is available in a Green TSSOP-14 package. They are specified over the extended -40 $^{\circ}$ C to +125 $^{\circ}$ C temperature range.

FEATURES

- **Wide Supply Voltage Range: 1.8V to 5.5V**
- **Low Quiescent Current: 2.5 μ A/Amplifier (TYP)**
- **Low Offset Voltage: 0.85mV (MAX)**
- **Low 0.1Hz to 10Hz Noise: 3.5 μ V_{P-P}**
- **CMRR: 100dB**
- **PSRR: 2.5 μ V/V**
- **Open-Loop Voltage Gain: 118dB**
- **-40 $^{\circ}$ C to +125 $^{\circ}$ C Operating Temperature Range**
- **Small Packaging:**
 - SGM8049-1 Available in Green SC70-5, SOT-23-5 and TDFN-2 \times 2-6L Packages**
 - SGM8049-2 Available in Green SOT-23-8 and SOIC-8 Packages**
 - SGM8049-4 Available in a Green TSSOP-14 Package**

APPLICATIONS

Battery-Powered Systems
Wearable Devices
Portable Devices
Handheld Test Equipment
Medical Instruments

PACKAGE/ORDERING INFORMATION

MODEL	PACKAGE DESCRIPTION	SPECIFIED TEMPERATURE RANGE	ORDERING NUMBER	PACKAGE MARKING	PACKING OPTION
SGM8049-1	SOT-23-5	-40°C to +125°C	SGM8049-1XN5G/TR	SVAXX	Tape and Reel, 3000
	SC70-5	-40°C to +125°C	SGM8049-1AXC5G/TR	SZAXX	Tape and Reel, 3000
	SC70-5	-40°C to +125°C	SGM8049-1BXC5G/TR	SUEXX	Tape and Reel, 3000
	TDFN-2x2-6L	-40°C to +125°C	SGM8049-1XTDI6G/TR	SZC XXXX	Tape and Reel, 3000
SGM8049-2	SOT-23-8	-40°C to +125°C	SGM8049-2XN8G/TR	SVBXX	Tape and Reel, 3000
	SOIC-8	-40°C to +125°C	SGM8049-2XS8G/TR	SGM 80492XS8 XXXXX	Tape and Reel, 2500
SGM8049-4	TSSOP-14	-40°C to +125°C	SGM8049-4XTS14G/TR	SGM80494 XTS14 XXXXX	Tape and Reel, 4000

MARKING INFORMATION

NOTE: XX = Date Code. XXXX = Date Code. XXXXX = Date Code and Vendor Code.

SOT-23-5/SC70-5/SOT-23-8

YYY X X

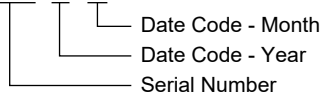

SOIC-8/TSSOP-14

XXXXX

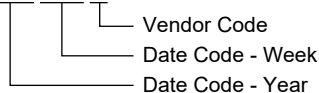

TDFN-2x2-6L

YYY — Serial Number

XXX

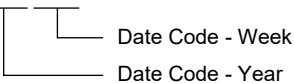

Green (RoHS & HSF): SG Micro Corp defines "Green" to mean Pb-Free (RoHS compatible) and free of halogen substances. If you have additional comments or questions, please contact your SGMICRO representative directly.

ABSOLUTE MAXIMUM RATINGS

Supply Voltage, +V _S to -V _S	6V
Signal Input Terminals, Voltage (-V _S) - 0.3V to (+V _S) + 0.3V	
Signal Input Terminals, Current	±10mA
Output Short-Circuit Current	30mA
Junction Temperature	+150°C
Storage Temperature Range	-65°C to +150°C
Lead Temperature (Soldering, 10s)	+260°C
ESD Susceptibility	
HBM	6000V
MM	400V
CDM	1000V

RECOMMENDED OPERATING CONDITIONS

Input Voltage Range	1.8V to 5.5V
Operating Temperature Range	-40°C to +125°C

OVERSTRESS CAUTION

Stresses beyond those listed in Absolute Maximum Ratings may cause permanent damage to the device. Exposure to absolute maximum rating conditions for extended periods may affect reliability. Functional operation of the device at any conditions beyond those indicated in the Recommended Operating Conditions section is not implied.

ESD SENSITIVITY CAUTION

This integrated circuit can be damaged if ESD protections are not considered carefully. SGMICRO recommends that all integrated circuits be handled with appropriate precautions. Failure to observe proper handling and installation procedures can cause damage. ESD damage can range from subtle performance degradation to complete device failure. Precision integrated circuits may be more susceptible to damage because even small parametric changes could cause the device not to meet the published specifications.

DISCLAIMER

SG Micro Corp reserves the right to make any change in circuit design, or specifications without prior notice.

PIN CONFIGURATIONS

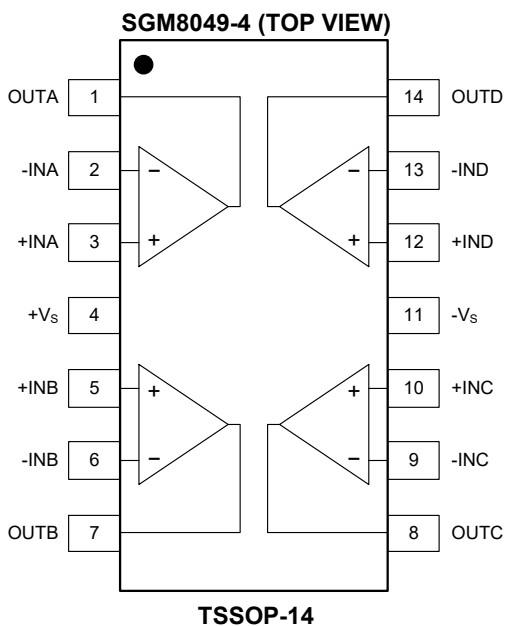
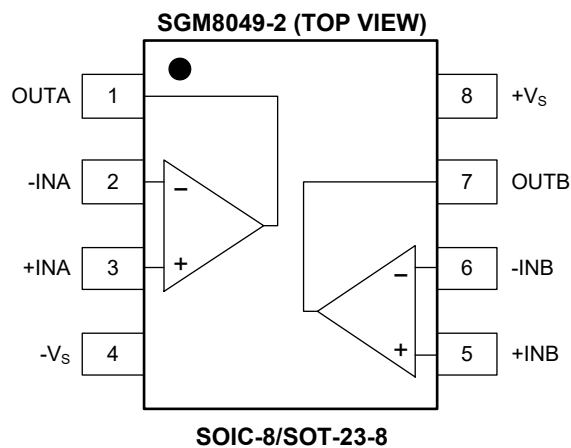
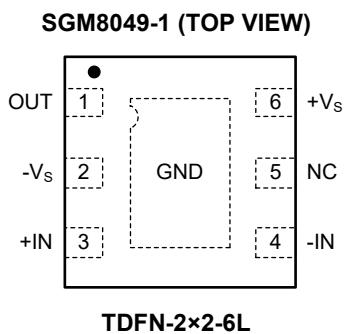
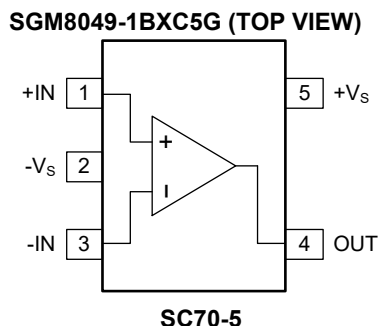
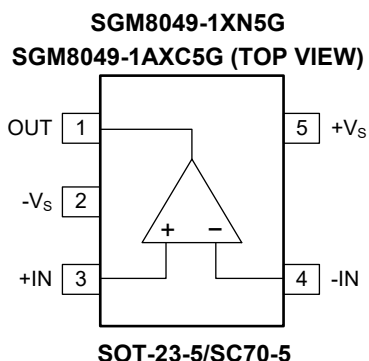

ELECTRICAL CHARACTERISTICS

(At $T_A = +25^\circ\text{C}$, $V_S = 1.8\text{V}$ to 5.5V , $R_L = 25\text{k}\Omega$ connected to $V_S/2$ and $V_{CM} < (+V_S) - 1.2\text{V}$, unless otherwise noted.)

PARAMETER	SYMBOL	CONDITIONS	MIN	TYP	MAX	UNITS
Input Characteristics						
Input Offset Voltage	V_{OS}	$V_S = 5\text{V}$		0.2	0.85	mV
		$-40^\circ\text{C} \leq T_A \leq +125^\circ\text{C}$			1	
Input Bias Current	I_B	$V_S = 5\text{V}$, $V_{CM} \leq V_S/2$		± 1		pA
Input Offset Current	I_{OS}	$V_S = 5\text{V}$		± 1		pA
Input Common Mode Voltage Range	V_{CM}		$(-V_S) - 0.1$		$(+V_S) + 0.1$	V
Common Mode Rejection Ratio	CMRR	$-V_S < V_{CM} < (+V_S) - 1.2\text{V}$	81	100		dB
		$-40^\circ\text{C} \leq T_A \leq +85^\circ\text{C}$	80			
		$-40^\circ\text{C} \leq T_A \leq +125^\circ\text{C}$	75			
Open-Loop Voltage Gain	A_{OL}	$V_S = 5\text{V}$, $R_L = 25\text{k}\Omega$, $100\text{mV} < V_{OUT} < (+V_S) - 100\text{mV}$	100	118		dB
		$-40^\circ\text{C} \leq T_A \leq +125^\circ\text{C}$	98			
		$V_S = 5\text{V}$, $R_L = 5\text{k}\Omega$, $500\text{mV} < V_{OUT} < (+V_S) - 500\text{mV}$	100	116		
		$-40^\circ\text{C} \leq T_A \leq +125^\circ\text{C}$	98			
Input Offset Voltage Drift	$\Delta V_{OS}/\Delta T$	$-40^\circ\text{C} \leq T_A \leq +85^\circ\text{C}$		0.5		$\mu\text{V}/^\circ\text{C}$
		$-40^\circ\text{C} \leq T_A \leq +125^\circ\text{C}$		0.6		
Output Characteristics						
Output Voltage Swing from Rail		$R_L = 25\text{k}\Omega$		5	14	mV
		$-40^\circ\text{C} \leq T_A \leq +125^\circ\text{C}$			15.5	
		$R_L = 5\text{k}\Omega$		25	40	
		$-40^\circ\text{C} \leq T_A \leq +125^\circ\text{C}$			46	
Output Short-Circuit Current	I_{SC}	$V_S = 5\text{V}$		20		mA
Power Supply						
Operating Voltage Range	V_S		1.8		5.5	V
Quiescent Current/Amplifier	I_Q	$V_S = 5.5\text{V}$, $I_{OUT} = 0\text{mA}$		2.5	4.2	μA
		$-40^\circ\text{C} \leq T_A \leq +125^\circ\text{C}$			6.5	
Power Supply Rejection Ratio	PSRR	$V_S = 1.8\text{V}$ to 5.5V , $V_{CM} = 0.6\text{V}$		2.5	12	$\mu\text{V}/\text{V}$
		$-40^\circ\text{C} \leq T_A \leq +125^\circ\text{C}$			14	
Dynamic Performance ($C_{LOAD} = 30\text{pF}$)						
Gain-Bandwidth Product	GBP			120		kHz
Slew Rate	SR	$G = +1$		0.08		$\text{V}/\mu\text{s}$
Overload Recovery Time		$V_{IN} \times G > V_S$		25		μs
Turn-On Time	t_{ON}			0.2		ms
Noise						
Input Voltage Noise		$f = 0.1\text{Hz}$ to 10Hz		3.5		μV_{P-P}
Input Voltage Noise Density	e_n	$f = 1\text{kHz}$		75		$\text{nV}/\sqrt{\text{Hz}}$
Input Current Noise Density	i_n	$f = 1\text{kHz}$		0.2		$\text{pA}/\sqrt{\text{Hz}}$

TYPICAL PERFORMANCE CHARACTERISTICS

At $T_A = +25^\circ\text{C}$, $V_S = 5\text{V}$ and $R_L = 25\text{k}\Omega$ connected to $V_S/2$, unless otherwise noted.

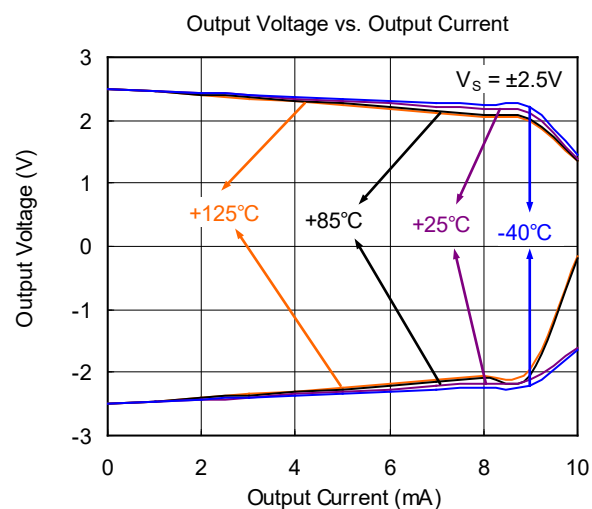
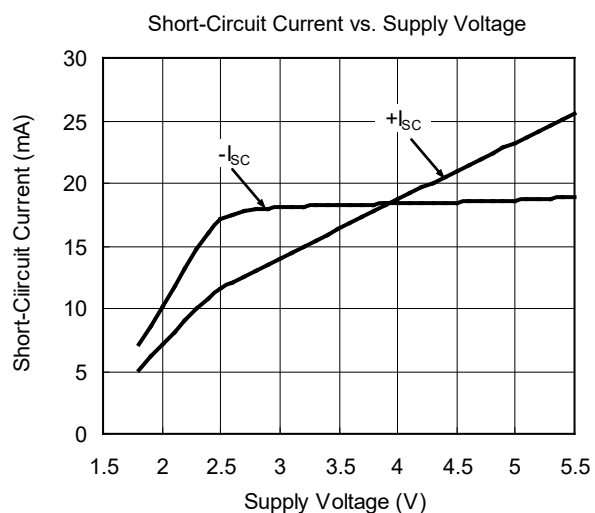
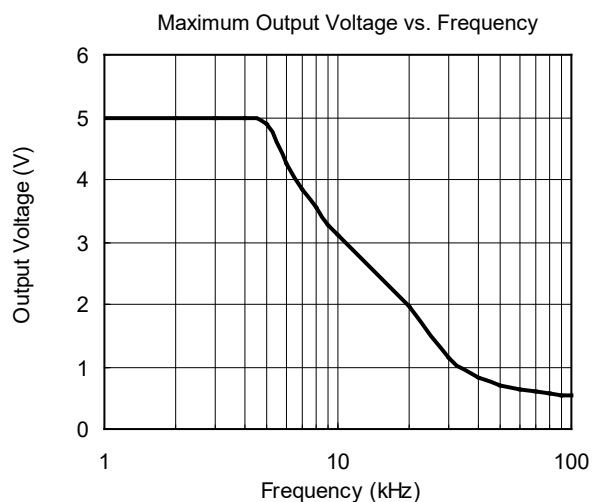
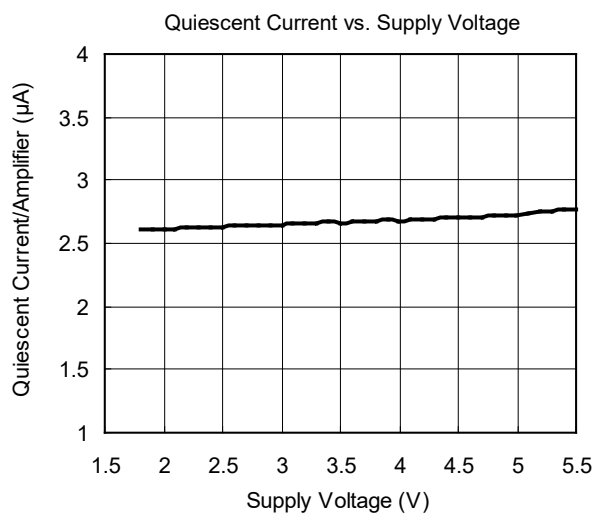
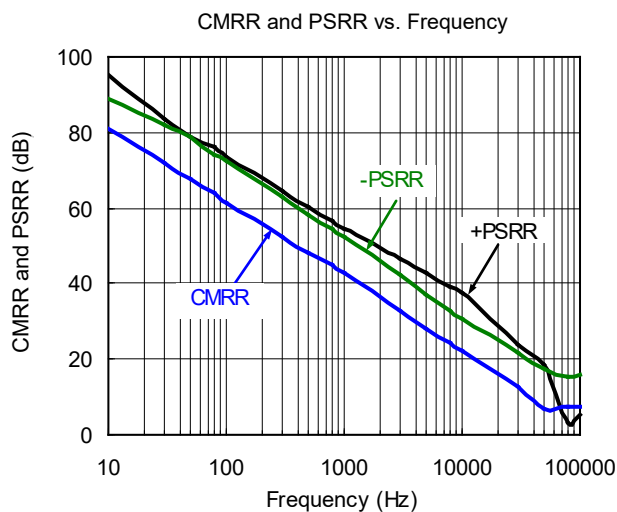
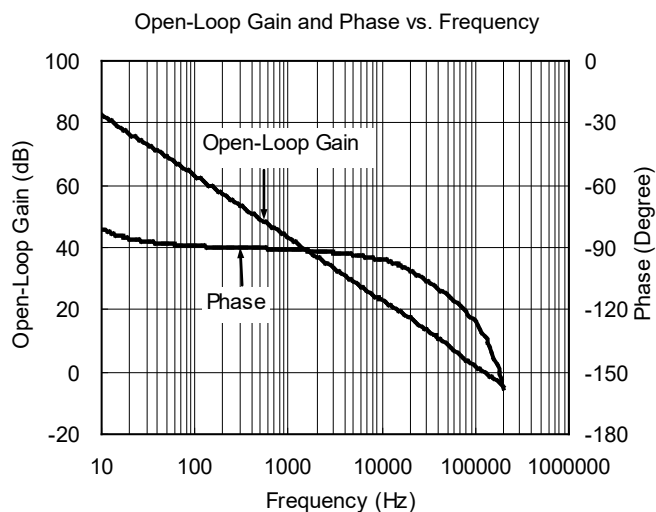

TYPICAL PERFORMANCE CHARACTERISTICS (continued)

At $T_A = +25^\circ\text{C}$, $V_S = 5\text{V}$ and $R_L = 25\text{k}\Omega$ connected to $V_S/2$, unless otherwise noted.

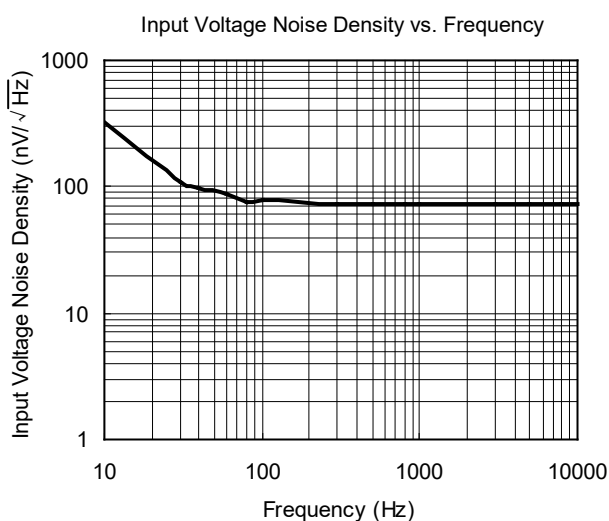
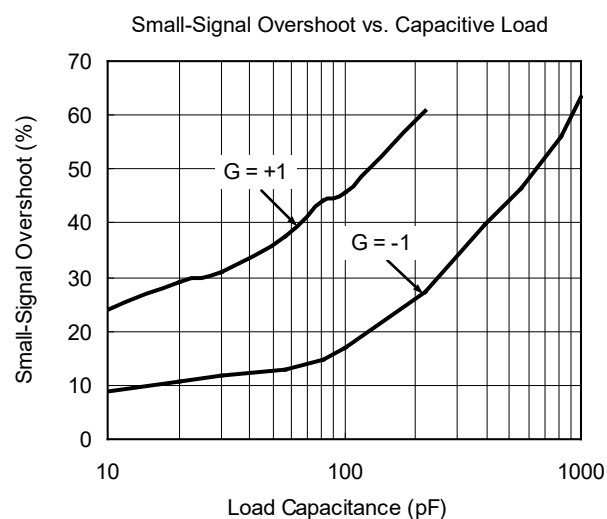
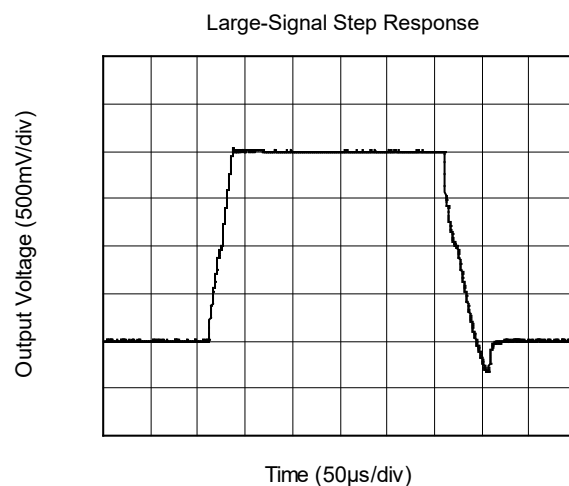
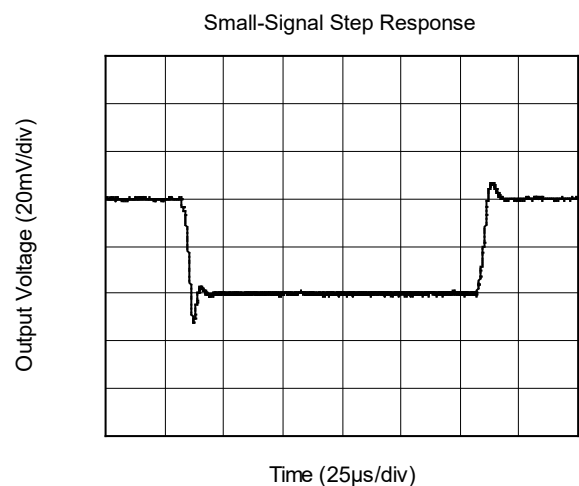
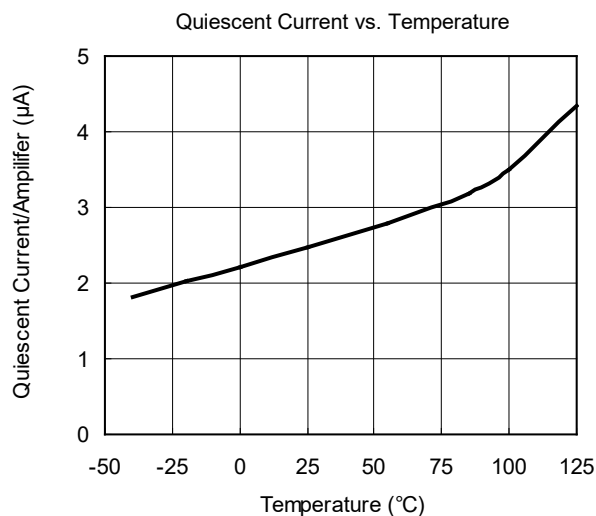
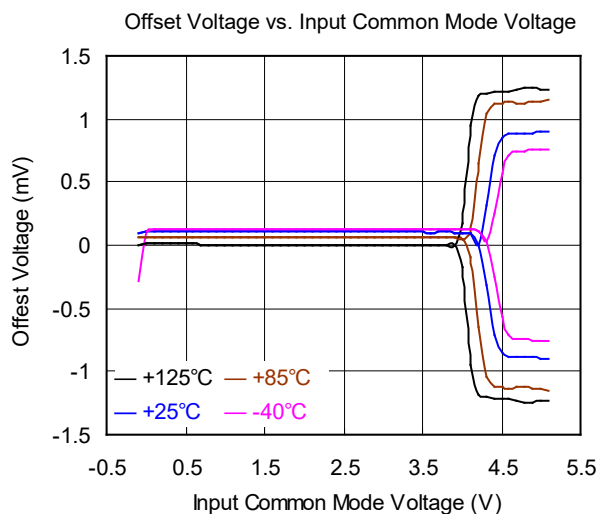

TYPICAL PERFORMANCE CHARACTERISTICS (continued)

At $T_A = +25^\circ\text{C}$, $V_S = 5\text{V}$ and $R_L = 25\text{k}\Omega$ connected to $V_S/2$, unless otherwise noted.

0.1Hz to 10Hz Noise

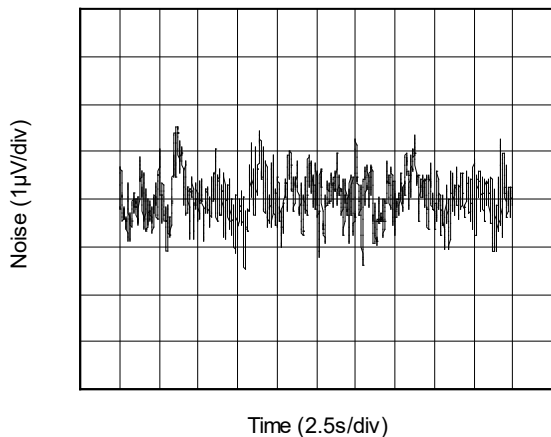

+IN EMIRR vs. Frequency

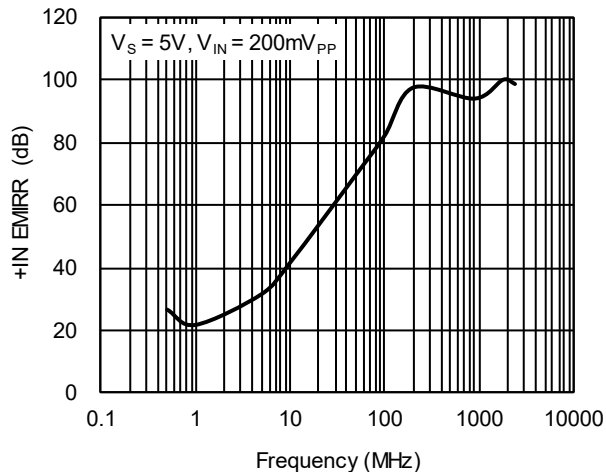

Offset Voltage Production Distribution

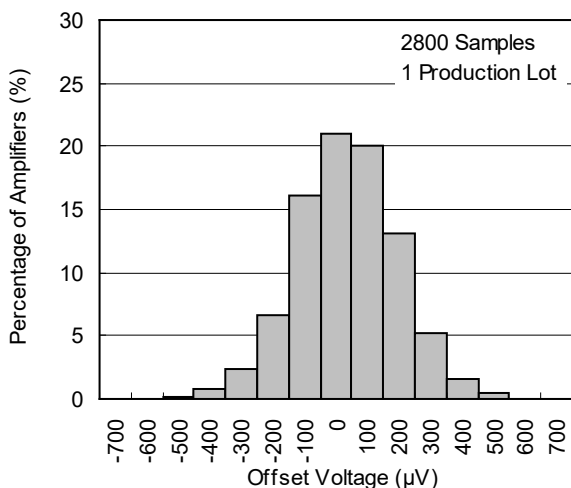

Offset Voltage Drift Distribution

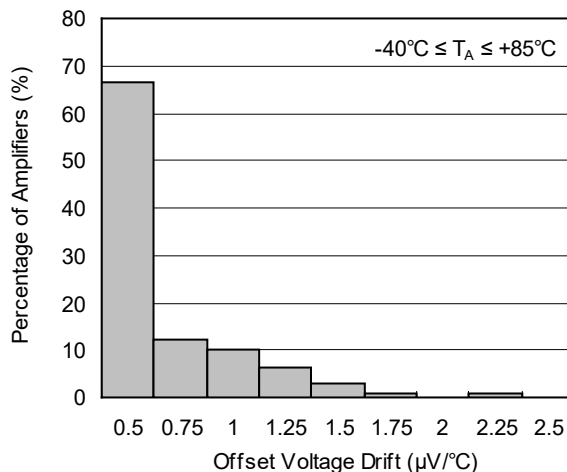

Offset Voltage Drift Distribution

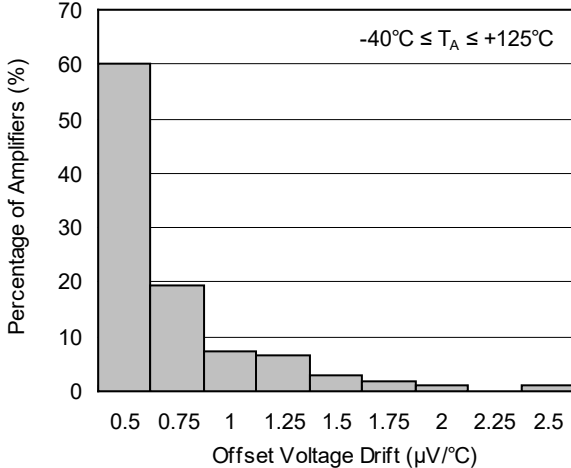

Quiescent Current Production Distribution

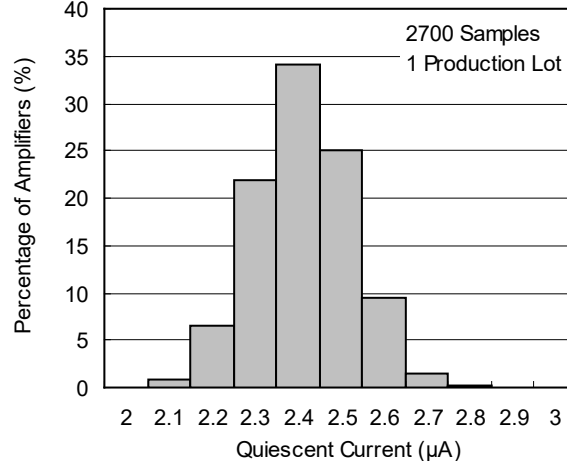

REVISION HISTORY

NOTE: Page numbers for previous revisions may differ from page numbers in the current version.

AUGUST 2017 – REV.A to REV.A.1	Page
Added +IN EMIRR vs. Frequency.....	8

Changes from Original (NOVEMBER 2015) to REV.A	Page
Changed from product preview to production data.....	All

PACKAGE OUTLINE DIMENSIONS

SC70-5

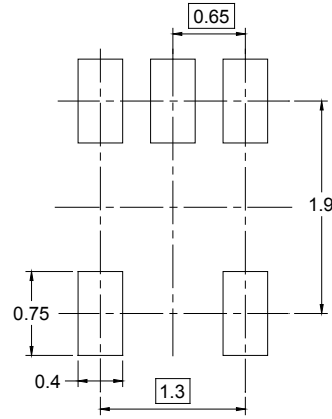
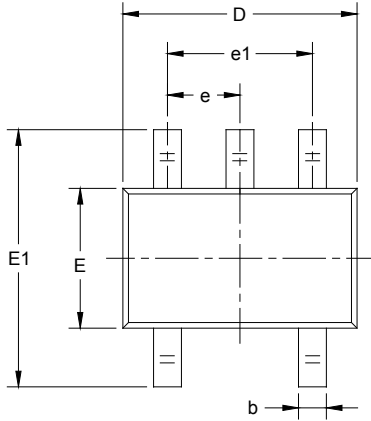

RECOMMENDED LAND PATTERN (Unit: mm)

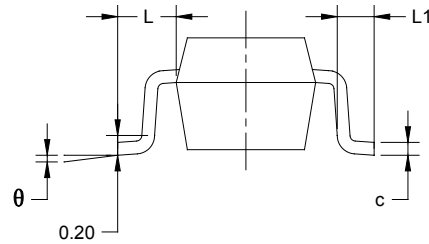
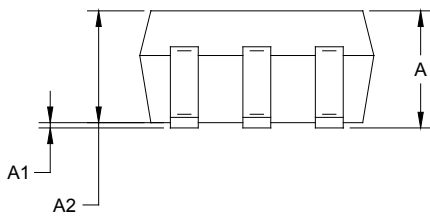

Symbol	Dimensions In Millimeters		Dimensions In Inches	
	MIN	MAX	MIN	MAX
A	0.900	1.100	0.035	0.043
A1	0.000	0.100	0.000	0.004
A2	0.900	1.000	0.035	0.039
b	0.150	0.350	0.006	0.014
c	0.080	0.150	0.003	0.006
D	2.000	2.200	0.079	0.087
E	1.150	1.350	0.045	0.053
E1	2.150	2.450	0.085	0.096
e	0.65 TYP		0.026 TYP	
e1	1.300 BSC		0.051 BSC	
L	0.525 REF		0.021 REF	
L1	0.260	0.460	0.010	0.018
θ	0°	8°	0°	8°

PACKAGE OUTLINE DIMENSIONS

SOT-23-5

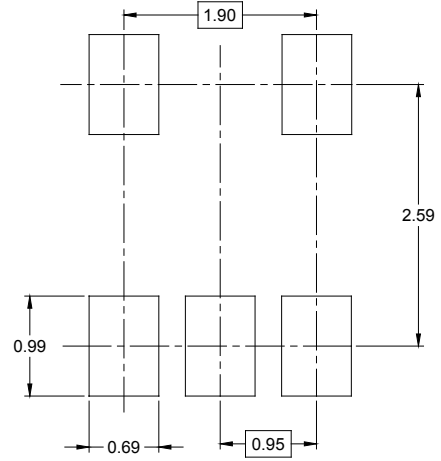
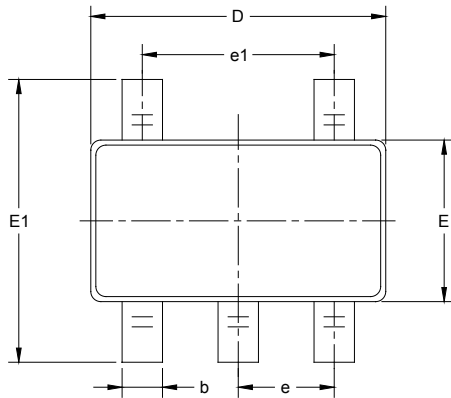

RECOMMENDED LAND PATTERN (Unit: mm)

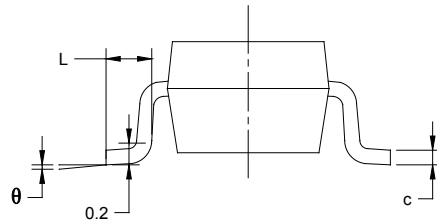
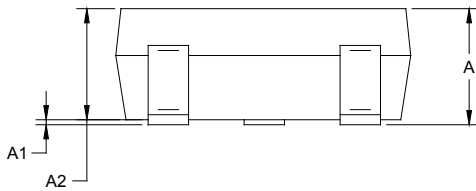

Symbol	Dimensions In Millimeters		Dimensions In Inches	
	MIN	MAX	MIN	MAX
A	1.050	1.250	0.041	0.049
A1	0.000	0.100	0.000	0.004
A2	1.050	1.150	0.041	0.045
b	0.300	0.500	0.012	0.020
c	0.100	0.200	0.004	0.008
D	2.820	3.020	0.111	0.119
E	1.500	1.700	0.059	0.067
E1	2.650	2.950	0.104	0.116
e	0.950 BSC		0.037 BSC	
e1	1.900 BSC		0.075 BSC	
L	0.300	0.600	0.012	0.024
θ	0°	8°	0°	8°

PACKAGE OUTLINE DIMENSIONS

TDFN-2x2-6L

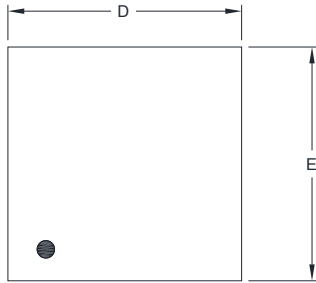

TOP VIEW

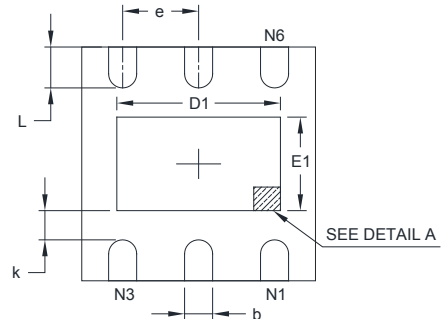

BOTTOM VIEW

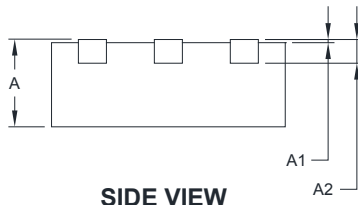

SIDE VIEW

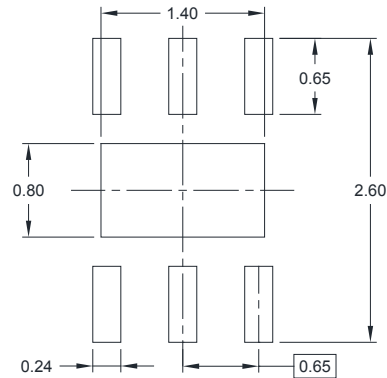

RECOMMENDED LAND PATTERN (Unit: mm)

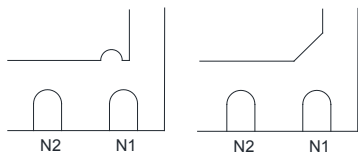

DETAIL A

Pin #1 ID and Tie Bar Mark Options

NOTE: The configuration of the Pin #1 identifier is optional, but must be located within the zone indicated.

Symbol	Dimensions In Millimeters		Dimensions In Inches	
	MIN	MAX	MIN	MAX
A	0.700	0.800	0.028	0.031
A1	0.000	0.050	0.000	0.002
A2	0.203 REF		0.008 REF	
D	1.900	2.100	0.075	0.083
D1	1.100	1.450	0.043	0.057
E	1.900	2.100	0.075	0.083
E1	0.600	0.850	0.024	0.034
k	0.200 MIN		0.008 MIN	
b	0.180	0.300	0.007	0.012
e	0.650 TYP		0.026 TYP	
L	0.250	0.450	0.010	0.018

PACKAGE OUTLINE DIMENSIONS

SOT-23-8

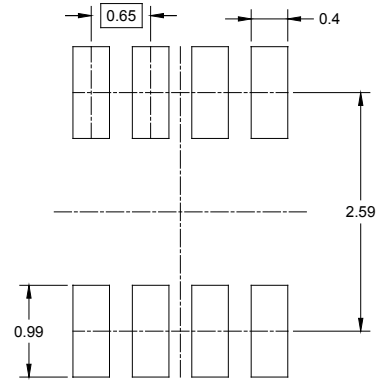
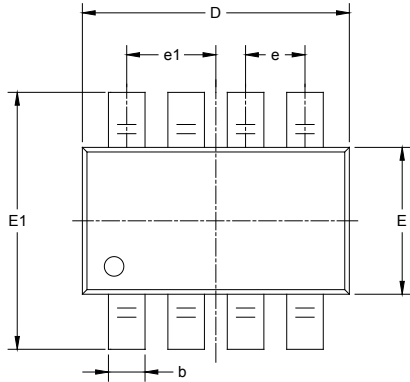

RECOMMENDED LAND PATTERN (Unit: mm)

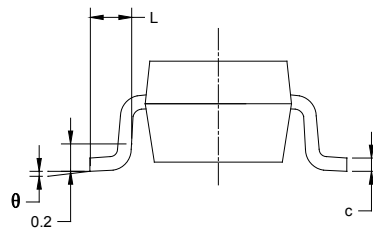
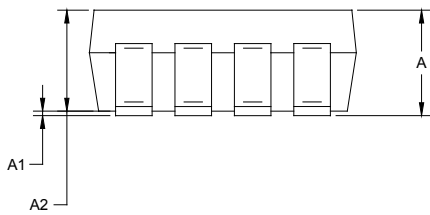

Symbol	Dimensions In Millimeters		Dimensions In Inches	
	MIN	MAX	MIN	MAX
A	1.050	1.250	0.041	0.049
A1	0.000	0.100	0.000	0.004
A2	1.050	1.150	0.041	0.045
b	0.300	0.500	0.012	0.020
c	0.100	0.200	0.004	0.008
D	2.820	3.020	0.111	0.119
E	1.500	1.700	0.059	0.067
E1	2.650	2.950	0.104	0.116
e	0.650 BSC		0.026 BSC	
e1	0.975 BSC		0.038 BSC	
L	0.300	0.600	0.012	0.024
θ	0°	8°	0°	8°

PACKAGE OUTLINE DIMENSIONS

SOIC-8

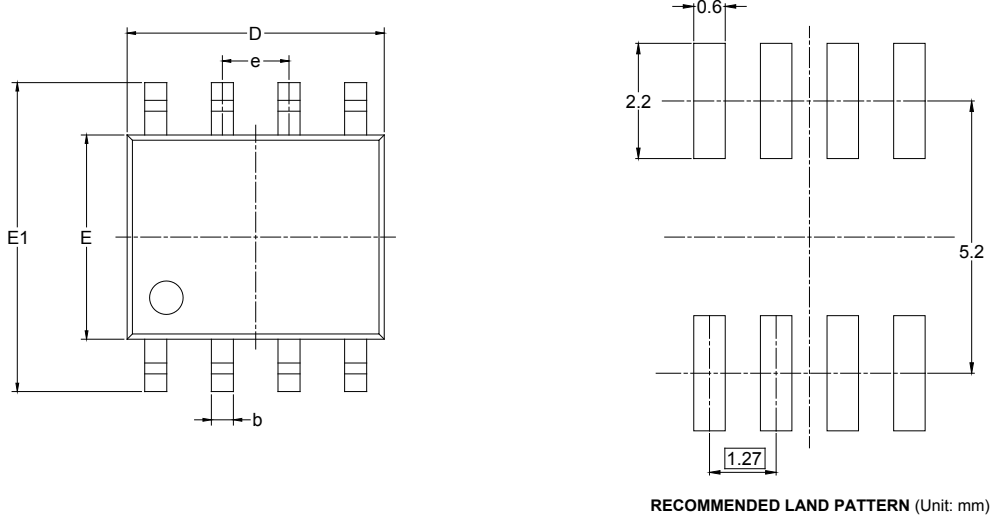

Symbol	Dimensions In Millimeters		Dimensions In Inches	
	MIN	MAX	MIN	MAX
A	1.350	1.750	0.053	0.069
A1	0.100	0.250	0.004	0.010
A2	1.350	1.550	0.053	0.061
b	0.330	0.510	0.013	0.020
c	0.170	0.250	0.006	0.010
D	4.700	5.100	0.185	0.200
E	3.800	4.000	0.150	0.157
E1	5.800	6.200	0.228	0.244
e	1.27 BSC		0.050 BSC	
L	0.400	1.270	0.016	0.050
θ	0°	8°	0°	8°

PACKAGE OUTLINE DIMENSIONS

TSSOP-14

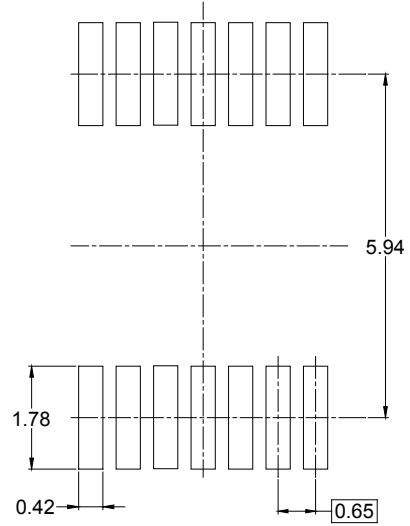
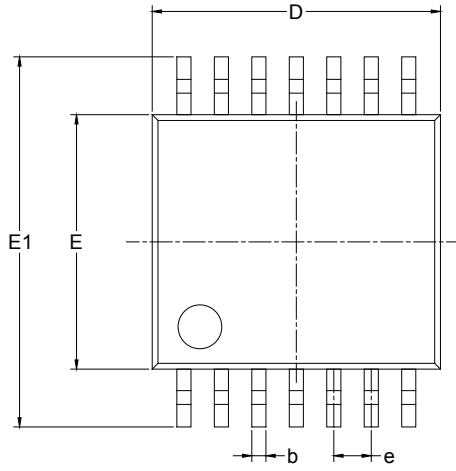

RECOMMENDED LAND PATTERN (Unit: mm)

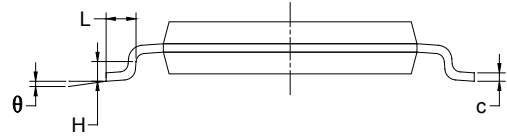
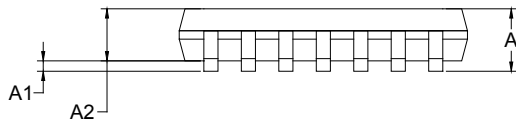

Symbol	Dimensions In Millimeters		Dimensions In Inches	
	MIN	MAX	MIN	MAX
A		1.200		0.047
A1	0.050	0.150	0.002	0.006
A2	0.800	1.050	0.031	0.041
b	0.190	0.300	0.007	0.012
c	0.090	0.200	0.004	0.008
D	4.860	5.100	0.191	0.201
E	4.300	4.500	0.169	0.177
E1	6.250	6.550	0.246	0.258
e	0.650 BSC		0.026 BSC	
L	0.500	0.700	0.02	0.028
H	0.25 TYP		0.01 TYP	
θ	1°	7°	1°	7°

PACKAGE INFORMATION

TAPE AND REEL INFORMATION

REEL DIMENSIONS

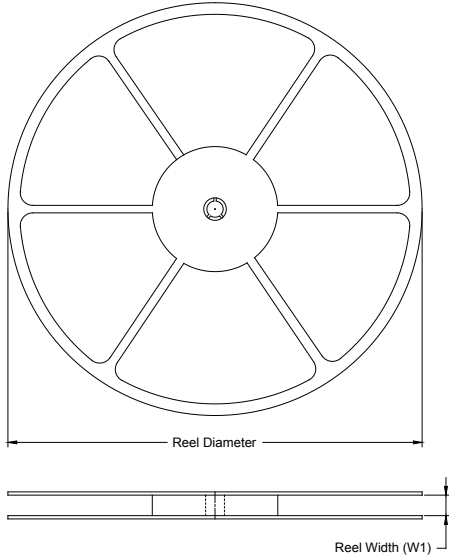

TAPE DIMENSIONS

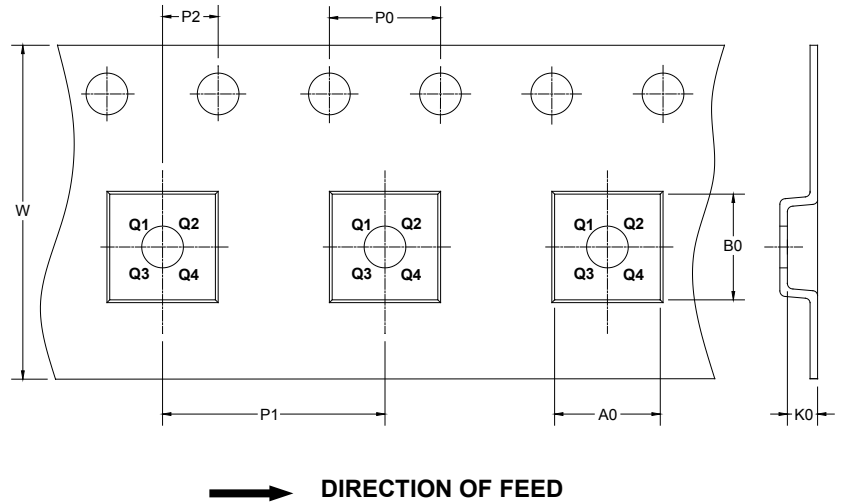

NOTE: The picture is only for reference. Please make the object as the standard.

KEY PARAMETER LIST OF TAPE AND REEL

Package Type	Reel Diameter	Reel Width W1 (mm)	A0 (mm)	B0 (mm)	K0 (mm)	P0 (mm)	P1 (mm)	P2 (mm)	W (mm)	Pin1 Quadrant
SC70-5	7"	9.5	2.25	2.55	1.20	4.0	4.0	2.0	8.0	Q3
SOT-23-5	7"	9.5	3.20	3.20	1.40	4.0	4.0	2.0	8.0	Q3
TDFN-2×2-6L	7"	9.5	2.30	2.30	1.10	4.0	4.0	2.0	8.0	Q1
SOT-23-8	7"	9.5	3.17	3.23	1.37	4.0	4.0	2.0	8.0	Q3
SOIC-8	13"	12.4	6.40	5.40	2.10	4.0	8.0	2.0	12.0	Q1
TSSOP-14	13"	12.4	6.95	5.60	1.20	4.0	8.0	2.0	12.0	Q1

D00001

PACKAGE INFORMATION

CARTON BOX DIMENSIONS



NOTE: The picture is only for reference. Please make the object as the standard.

KEY PARAMETER LIST OF CARTON BOX

Reel Type	Length (mm)	Width (mm)	Height (mm)	Pizza/Carton
7" (Option)	368	227	224	8
7"	442	410	224	18
13"	386	280	370	5

DD0002