



# SGM8603

## 1.1mA, 11MHz, Low Noise, Rail-to-Rail I/O Tiny Package, CMOS Operational Amplifier

---

### GENERAL DESCRIPTION

The SGM8603 (single with shutdown) is a low voltage, low noise and low power operational amplifier, which can operate from 2.1V to 5.5V single supply, while consuming only 1.1mA quiescent current at 5V. The supply current is less than 1 $\mu$ A in power-down mode.

The SGM8603 features a 4.9mV maximum input offset voltage. The minimum input common mode voltage is within 0.1V below the negative rail, and the output swing is rail-to-rail with heavy loads. It exhibits a high gain-bandwidth product of 11MHz and a slew rate of 8.5V/ $\mu$ s. These specifications make the operational amplifier appropriate for various applications.

The SGM8603 is available in a Green TDFN-2 $\times$ 2-6L package. It is specified over the extended -40 $^{\circ}$ C to +125 $^{\circ}$ C industrial temperature range.

### FEATURES

- **Input Offset Voltage: 1.1mV (TYP)**
- **High Gain-Bandwidth Product: 11MHz**
- **High Slew Rate: 8.5V/ $\mu$ s**
- **Settling Time to 0.1% with 2V Step: 0.21 $\mu$ s**
- **Overload Recovery Time: 0.6 $\mu$ s**
- **Low Noise: 8.5nV/ $\sqrt{\text{Hz}}$  at 10kHz**
- **Rail-to-Rail Input and Output**
- **Supply Voltage Range: 2.1V to 5.5V**
- **Input Voltage Range: -0.1V to 5.6V with  $V_S = 5.5V$**
- **Low Power:**
  - 1.1mA (TYP) Supply Current
  - Less than 1 $\mu$ A when Disabled
- **-40 $^{\circ}$ C to +125 $^{\circ}$ C Operating Temperature Range**
- **Available in a Green TDFN-2 $\times$ 2-6L Package**

### APPLICATIONS

Sensors  
Audio  
Active Filters  
A/D Converters  
Communications  
Test Equipment  
Cellular and Cordless Phones  
Laptops and PDAs  
Photodiode Amplification  
Battery-Powered Instrumentation

**PACKAGE/ORDERING INFORMATION**

MODEL	PACKAGE DESCRIPTION	SPECIFIED TEMPERATURE RANGE	ORDERING NUMBER	PACKAGE MARKING	PACKING OPTION
SGM8603	TDFN-2x2-6L	-40°C to +125°C	SGM8603XTDI6G/TR	8603 XXXX	Tape and Reel, 3000

**MARKING INFORMATION**

NOTE: XXXX = Date Code.

**XXXX**

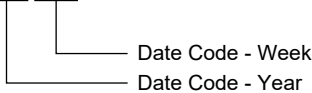

Green (RoHS & HSF): SG Micro Corp defines "Green" to mean Pb-Free (RoHS compatible) and free of halogen substances. If you have additional comments or questions, please contact your SGMICRO representative directly.

**ABSOLUTE MAXIMUM RATINGS**

- Supply Voltage, +Vs to -Vs .....6V
- Input Common Mode Voltage Range .....(-Vs) - 0.3V to (+Vs) + 0.3
- Junction Temperature.....+150°C
- Storage Temperature Range.....-65°C to +150°C
- Lead Temperature (Soldering, 10s).....+260°C
- ESD Susceptibility
- HBM.....4000V
- MM.....400V
- CDM .....1000V

**RECOMMENDED OPERATING CONDITIONS**

- Input Voltage Range .....2.1V to 5.5V
- Operating Temperature Range.....-40°C to +125°C

**OVERSTRESS CAUTION**

Stresses beyond those listed in Absolute Maximum Ratings may cause permanent damage to the device. Exposure to absolute maximum rating conditions for extended periods may affect reliability. Functional operation of the device at any conditions beyond those indicated in the Recommended Operating Conditions section is not implied.

**ESD SENSITIVITY CAUTION**

This integrated circuit can be damaged if ESD protections are not considered carefully. SGMICRO recommends that all integrated circuits be handled with appropriate precautions. Failure to observe proper handling and installation procedures can cause damage. ESD damage can range from subtle performance degradation to complete device failure. Precision integrated circuits may be more susceptible to damage because even small parametric changes could cause the device not to meet the published specifications.

**DISCLAIMER**

SG Micro Corp reserves the right to make any change in circuit design, or specifications without prior notice.

**PIN CONFIGURATION**

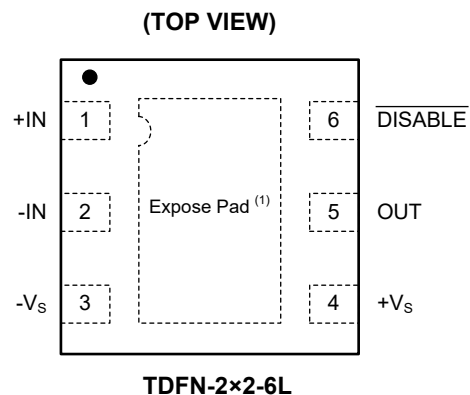

NOTE 1: Exposed pad can be connected to -Vs or left floating.

## ELECTRICAL CHARACTERISTICS

(At  $T_A = +25^\circ\text{C}$ ,  $V_S = +5\text{V}$ ,  $V_{CM} = V_S/2$ ,  $R_L = 600\Omega$ , unless otherwise noted.)

PARAMETER	CONDITIONS	SGM8603						
		TYP	MIN/MAX OVER TEMPERATURE				UNITS	MIN/MAX
		+25°C	+25°C	-40°C to +85°C	-40°C to +125°C			
<b>Input Characteristics</b>								
Input Offset Voltage ( $V_{OS}$ )		1.1	4.9	5.1	5.4	mV	MAX	
Input Bias Current ( $I_B$ )		1				pA	TYP	
Input Offset Current ( $I_{OS}$ )		1				pA	TYP	
Input Common Mode Voltage Range ( $V_{CM}$ )	$V_S = 5.5\text{V}$	-0.1 to +5.6				V	TYP	
Common Mode Rejection Ratio (CMRR)	$V_S = 5.5\text{V}$ , $V_{CM} = -0.1\text{V}$ to $4\text{V}$	83	67	66	65	dB	MIN	
	$V_S = 5.5\text{V}$ , $V_{CM} = -0.1\text{V}$ to $5.6\text{V}$	77	61	60	56	dB	MIN	
Open-Loop Voltage Gain ( $A_{OL}$ )	$R_L = 600\Omega$ , $V_{OUT} = 0.15\text{V}$ to $4.85\text{V}$	91	85	73	62	dB	MIN	
	$R_L = 10\text{k}\Omega$ , $V_{OUT} = 0.05\text{V}$ to $4.95\text{V}$	105	97	84	69	dB	MIN	
Input Offset Voltage Drift ( $\Delta V_{OS}/\Delta T$ )		2.7				$\mu\text{V}/^\circ\text{C}$	TYP	
<b>Output Characteristics</b>								
Output Voltage Swing from Rail	$R_L = 600\Omega$	78	102	123	144	mV	MAX	
	$R_L = 10\text{k}\Omega$	7	12	14	20	mV	MAX	
Output Current ( $I_{OUT}$ )		64	52	25	19	mA	MIN	
Closed-Loop Output Impedance	$f = 1\text{MHz}$ , $G = 1$	8.5				$\Omega$	TYP	
<b>Power-Down Disable</b>								
Turn-On Time		1.1				$\mu\text{s}$	TYP	
Turn-Off Time		0.3				$\mu\text{s}$	TYP	
DISABLE Voltage-Off			0.8			V	MAX	
DISABLE Voltage-On			2			V	MIN	
<b>Power Supply</b>								
Operating Voltage Range			2.1	2.1	2.1	V	MIN	
			5.5	5.5	5.5	V	MAX	
Power Supply Rejection Ratio (PSRR)	$V_S = 2.1\text{V}$ to $5.5\text{V}$ , $V_{CM} = (-V_S) + 0.5\text{V}$	80	68	67	64	dB	MIN	
Quiescent Current ( $I_Q$ )	$I_{OUT} = 0$	1.1	1.4	1.6	1.75	mA	MAX	
Supply Current when Disabled		0.5	8	9	10	$\mu\text{A}$	MAX	
<b>Dynamic Performance</b>								
Gain-Bandwidth Product (GBP)	$R_L = 10\text{k}\Omega$	11				MHz	TYP	
Phase Margin ( $\phi_0$ )		62				$^\circ$	TYP	
Full Power Bandwidth ( $BW_P$ )	< 1% distortion	400				kHz	TYP	
Slew Rate (SR)	$G = 1$ , 2V output step	8.5				V/ $\mu\text{s}$	TYP	
Settling Time to 0.1% ( $t_s$ )	$G = 1$ , 2V output step	0.21				$\mu\text{s}$	TYP	
Overload Recovery Time	$V_{IN} \times G = V_S$	0.6				$\mu\text{s}$	TYP	
<b>Noise Performance</b>								
Input Voltage Noise Density ( $e_n$ )	$f = 1\text{kHz}$	12.5				$\text{nV}/\sqrt{\text{Hz}}$	TYP	
	$f = 10\text{kHz}$	8.5				$\text{nV}/\sqrt{\text{Hz}}$	TYP	

**ELECTRICAL CHARACTERISTICS (continued)**(At  $T_A = +25^\circ\text{C}$ ,  $V_S = +2.1\text{V}$ ,  $V_{CM} = V_S/2$ ,  $R_L = 600\Omega$ , unless otherwise noted.)

PARAMETER	CONDITIONS	SGM8603						
		TYP	MIN/MAX OVER TEMPERATURE				UNITS	MIN/MAX
		+25°C	+25°C	-40°C to +85°C	-40°C to +125°C			
<b>Input Characteristics</b>								
Input Offset Voltage ( $V_{OS}$ )		1	5.2	5.5	5.6	mV	MAX	
Input Bias Current ( $I_B$ )		1				pA	TYP	
Input Offset Current ( $I_{OS}$ )		1				pA	TYP	
Input Common Mode Voltage Range ( $V_{CM}$ )	$V_S = 2.1\text{V}$	-0.1 to +2.2				V	TYP	
Common Mode Rejection Ratio (CMRR)	$V_S = 2.1\text{V}$ , $V_{CM} = -0.1\text{V}$ to $0.6\text{V}$	77	60	59	51	dB	MIN	
	$V_S = 2.1\text{V}$ , $V_{CM} = -0.1\text{V}$ to $2.2\text{V}$	70	55	53	49	dB	MIN	
Open-Loop Voltage Gain ( $A_{OL}$ )	$R_L = 600\Omega$ , $V_{OUT} = 0.15\text{V}$ to $1.95\text{V}$	88	78	68	58	dB	MIN	
	$R_L = 10\text{k}\Omega$ , $V_{OUT} = 0.05\text{V}$ to $2.05\text{V}$	100	89	82	67	dB	MIN	
Input Offset Voltage Drift ( $\Delta V_{OS}/\Delta T$ )		2.9				$\mu\text{V}/^\circ\text{C}$	TYP	
<b>Output Characteristics</b>								
Output Voltage Swing from Rail	$R_L = 600\Omega$	38	50	59	66	mV	MAX	
	$R_L = 10\text{k}\Omega$	4	9	11	12	mV	MAX	
Output Current ( $I_{OUT}$ )		28	23	17	14	mA	MIN	
Closed-Loop Output Impedance	$f = 1\text{MHz}$ , $G = 1$	9.3				$\Omega$	TYP	
<b>Power-Down Disable</b>								
Turn-On Time		7.7				$\mu\text{s}$	TYP	
Turn-Off Time		0.5				$\mu\text{s}$	TYP	
DISABLE Voltage-Off			0.4			V	MAX	
DISABLE Voltage-On			1.8			V	MIN	
<b>Power Supply</b>								
Quiescent Current ( $I_Q$ )	$I_{OUT} = 0$	1.1	1.4	1.6	1.75	mA	MAX	
Supply Current when Disabled		0.5	8	9	10	$\mu\text{A}$	MAX	
<b>Dynamic Performance</b>								
Gain-Bandwidth Product (GBP)	$R_L = 10\text{k}\Omega$	11.5				MHz	TYP	
Phase Margin ( $\phi_o$ )		59				$^\circ$	TYP	
Full Power Bandwidth ( $BW_P$ )	< 1% distortion	400				kHz	TYP	
Slew Rate (SR)	$G = 1$ , 2V output step	8				$\text{V}/\mu\text{s}$	TYP	
Settling Time to 0.1% ( $t_s$ )	$G = 1$ , 2V output step	0.23				$\mu\text{s}$	TYP	
Overload Recovery Time	$V_{IN} \times G = V_S$	1				$\mu\text{s}$	TYP	
<b>Noise Performance</b>								
Input Voltage Noise Density ( $e_n$ )	$f = 1\text{kHz}$	15				$\text{nV}/\sqrt{\text{Hz}}$	TYP	
	$f = 10\text{kHz}$	9				$\text{nV}/\sqrt{\text{Hz}}$	TYP	

TYPICAL PERFORMANCE CHARACTERISTICS

At  $T_A = +25^\circ\text{C}$ ,  $V_{CM} = V_S/2$ ,  $R_L = 600\Omega$ , unless otherwise noted.

CMRR vs. Frequency

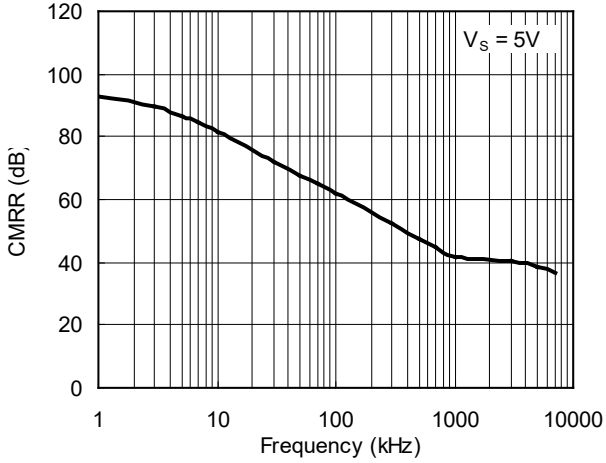

PSRR vs. Frequency

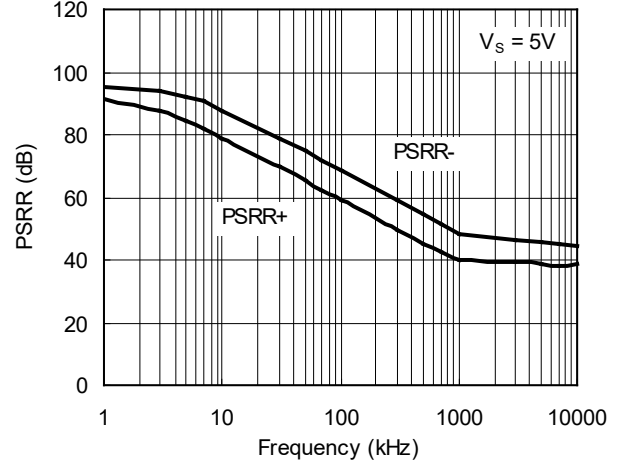

Output Voltage Swing vs. Output Current

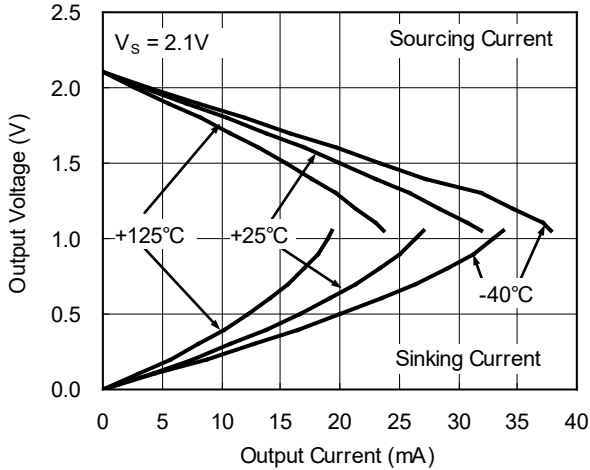

Output Voltage Swing vs. Output Current

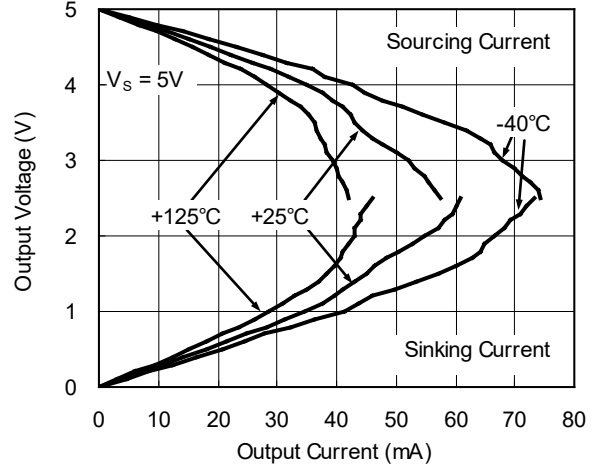

Closed-Loop Output Voltage Swing

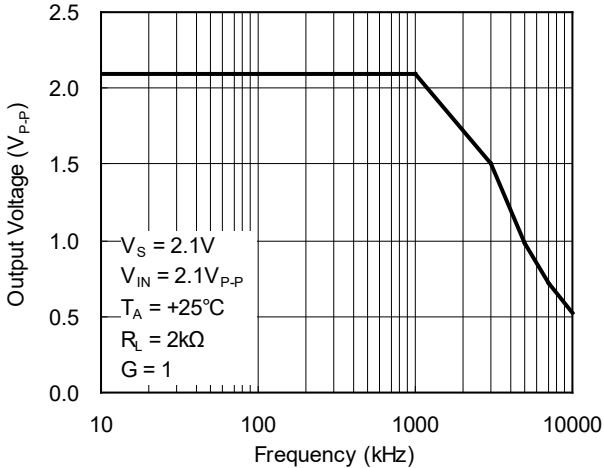

Closed-Loop Output Voltage Swing

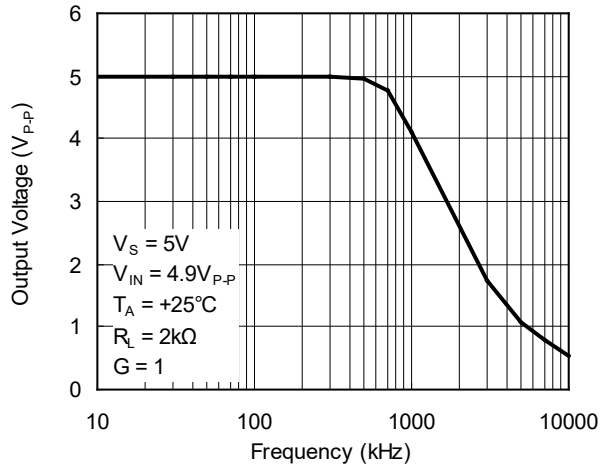

TYPICAL PERFORMANCE CHARACTERISTICS (continued)

At  $T_A = +25^\circ\text{C}$ ,  $V_{CM} = V_S/2$ ,  $R_L = 600\Omega$ , unless otherwise noted.

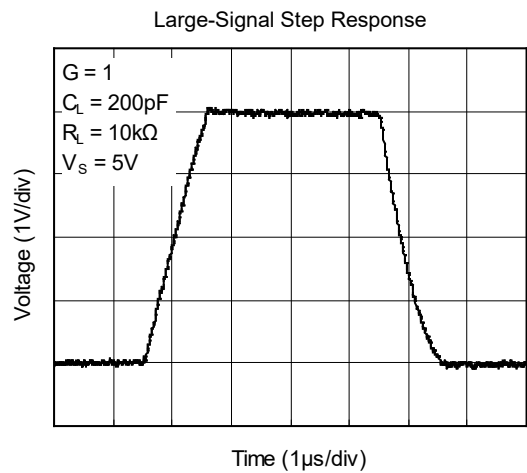
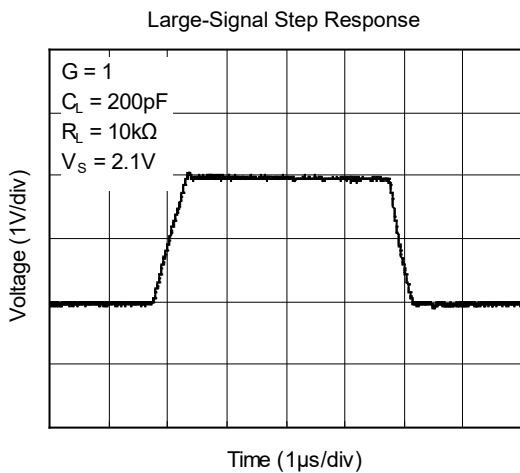
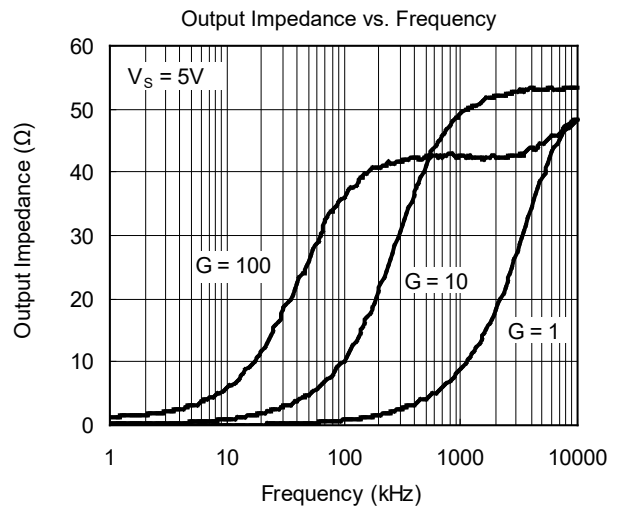
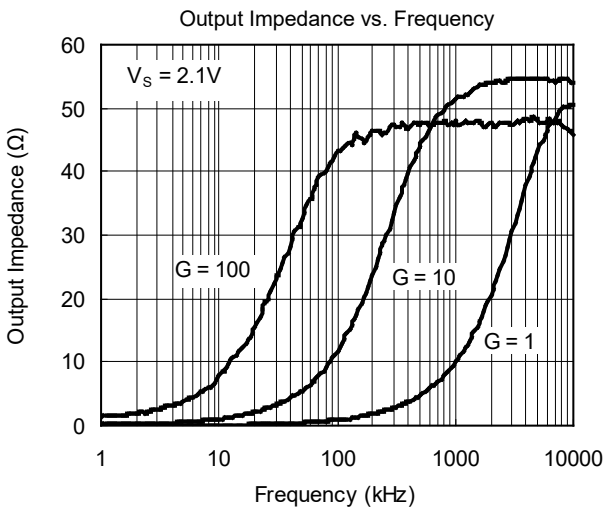
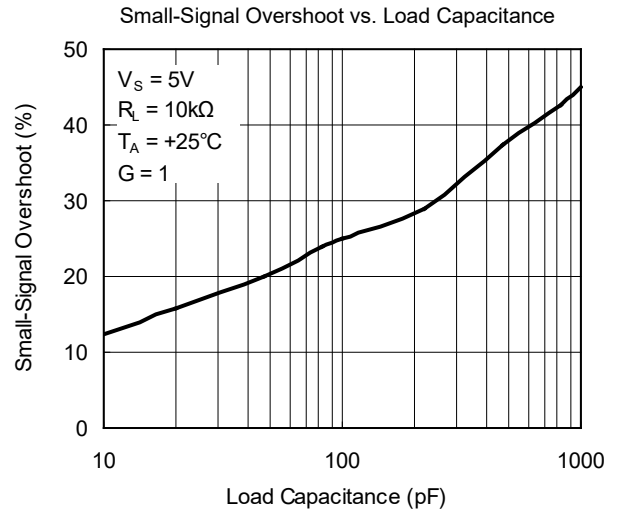
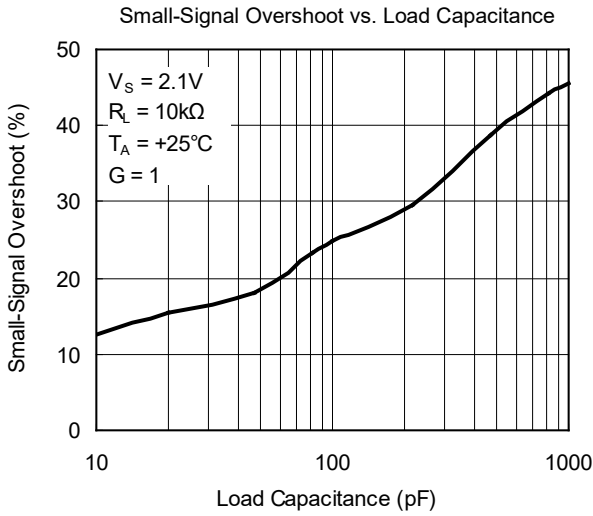

TYPICAL PERFORMANCE CHARACTERISTICS (continued)

At  $T_A = +25^\circ\text{C}$ ,  $V_{CM} = V_S/2$ ,  $R_L = 600\Omega$ , unless otherwise noted.

Small-Signal Step Response

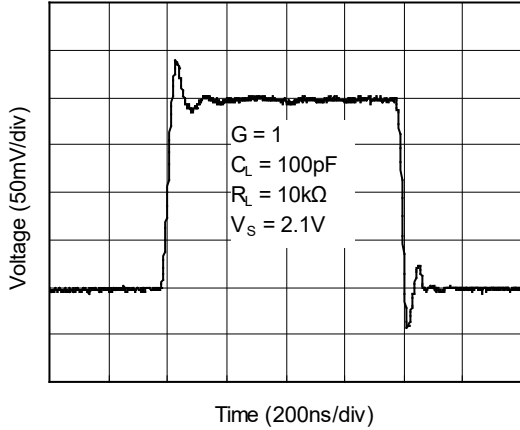

Small-Signal Step Response

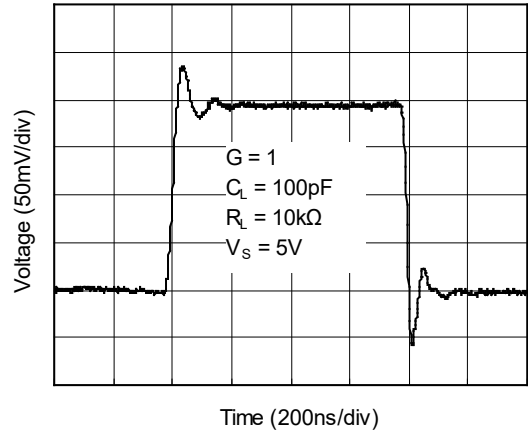

Positive Overload Recovery

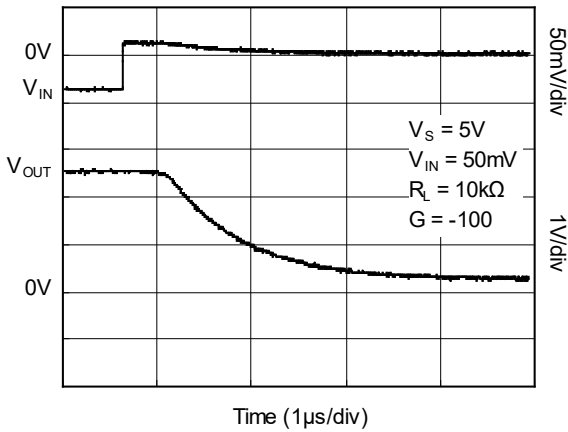

Negative Overload Recovery

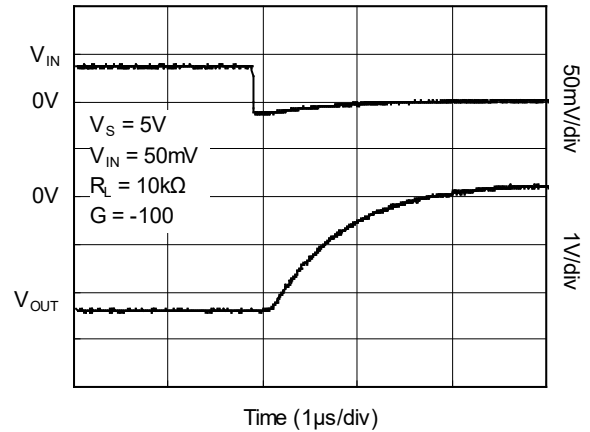

Supply Current vs. Temperature

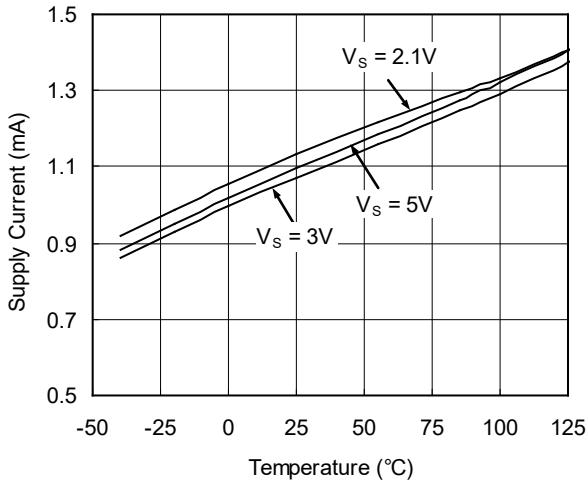

Input Voltage Noise Spectral Density vs. Frequency

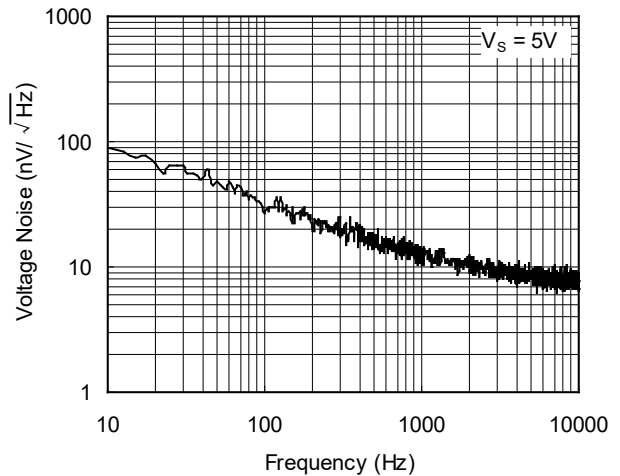

TYPICAL PERFORMANCE CHARACTERISTICS (continued)

At  $T_A = +25^\circ\text{C}$ ,  $V_{CM} = V_S/2$ ,  $R_L = 600\Omega$ , unless otherwise noted.

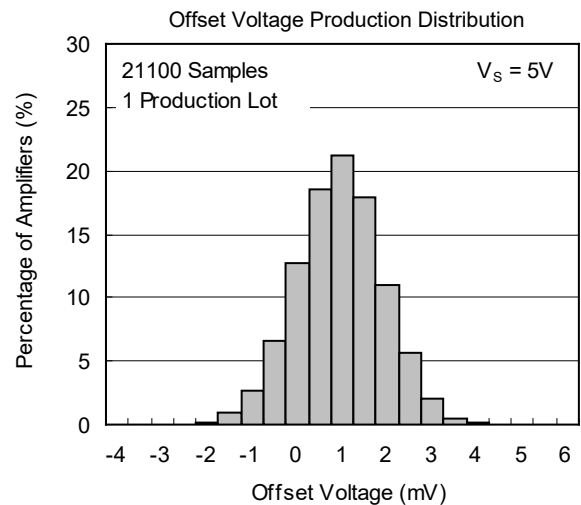
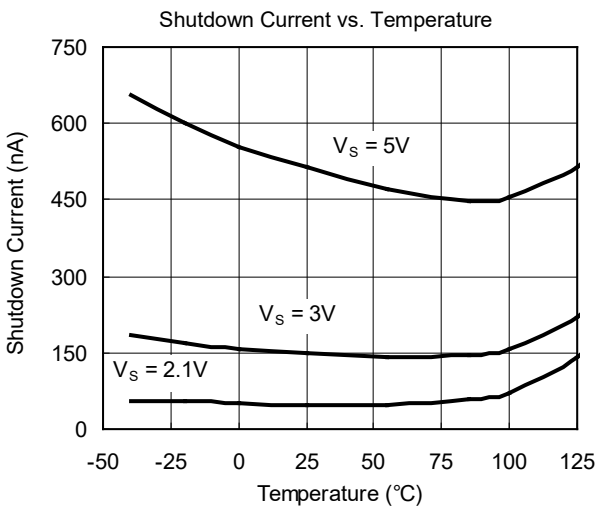
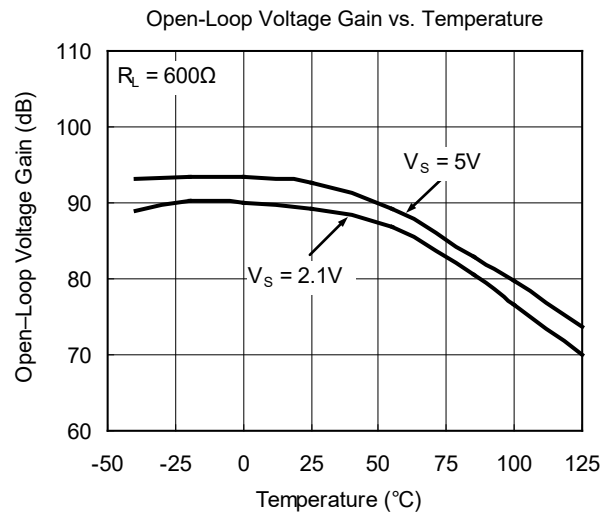
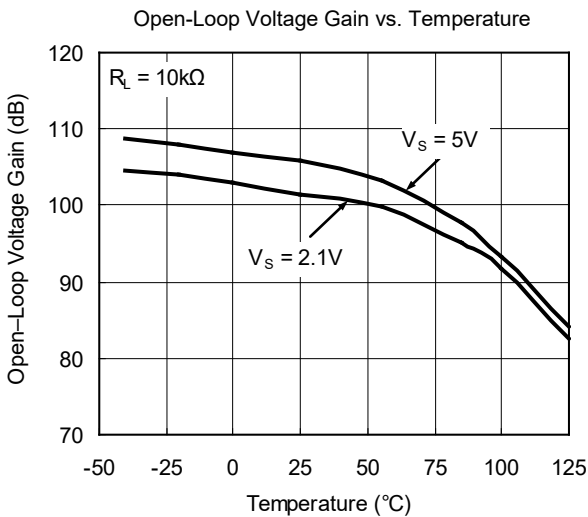
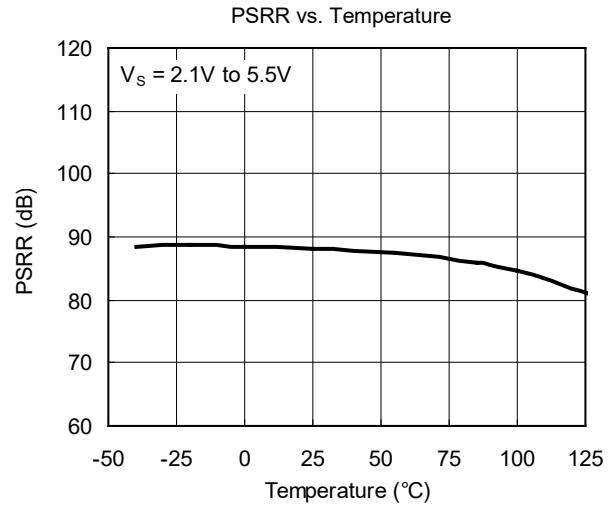
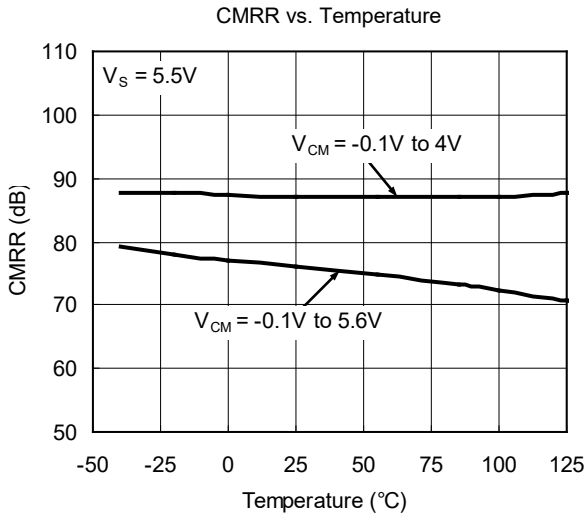



APPLICATION INFORMATION

Rail-to-Rail Input

When SGM8603 works at the power supply between 2.1V and 5.5V, the input common mode voltage range is from  $(-V_S) - 0.1V$  to  $(+V_S) + 0.1V$ . In Figure 1, the ESD diodes between the inputs and the power supply rails will clamp the input voltage not to exceed the rails.

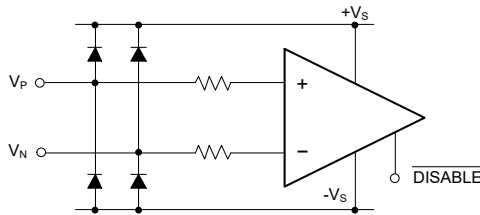

Figure 1. Input Equivalent Circuit

Rail-to-Rail Output

The SGM8603 supports rail-to-rail output operation. In single power supply application, for example, when  $+V_S = 5V$ ,  $-V_S = GND$ ,  $600\Omega$  load resistor is tied from OUT pin to ground, the typical output swing range is from 0.078V to 4.922V.

Driving Capacitive Loads

The SGM8603 is designed for unity-gain stable for capacitive load up to 4700pF. If greater capacitive load must be driven in application, the circuit in Figure 2 can be used. In this circuit, the IR drop voltage generated by  $R_{ISO}$  is compensated by feedback loop.

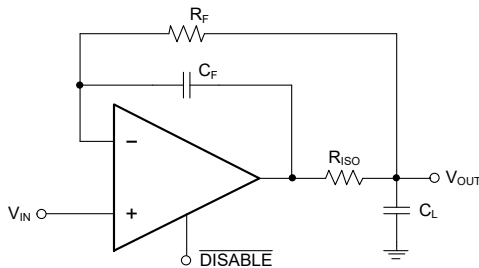

Figure 2. Circuit to Drive Heavy Capacitive Load

Power Supply Decoupling and Layout

A clean and low noise power supply is very important in amplifier circuit design, besides of input signal noise, the power supply is one of important source of noise to the amplifier through  $+V_S$  and  $-V_S$  pins. Power supply bypassing is an effective method to clear up the noise at power supply, and the low impedance path to ground of decoupling capacitor will bypass the noise to GND. In application,  $10\mu F$  ceramic capacitor paralleled with  $0.1\mu F$  or  $0.01\mu F$  ceramic capacitor is used in Figure 3. The ceramic capacitors should be placed as close as possible to  $+V_S$  and  $-V_S$  power supply pins.

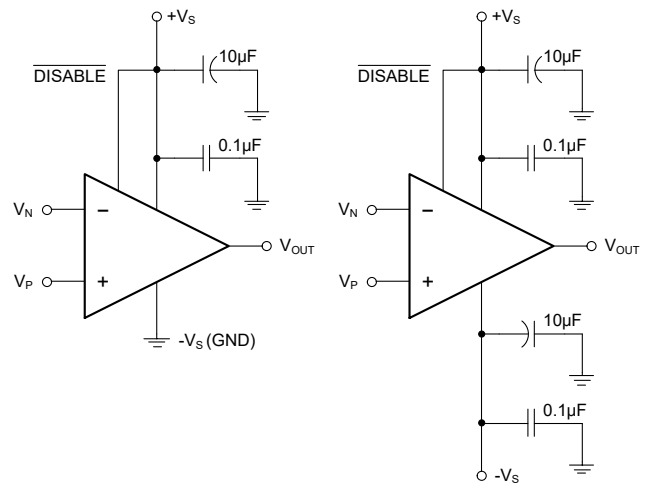

Figure 3. Amplifier Power Supply Bypassing

Grounding

In low speed application, one node grounding technique is the simplest and most effective method to eliminate the noise generated by grounding. In high speed application, the general method to eliminate noise is to use a complete ground plane technique, and the whole ground plane will help distribute heat and reduce EMI noise pickup.

Reduce Input-to-Output Coupling

To reduce the input-to-output coupling, the input traces must be placed as far away from the power supply or output traces as possible. The sensitive trace must not be placed in parallel with the noisy trace in same layer. They must be placed perpendicularly in different layers to reduce the crosstalk. These PCB layout techniques will help to reduce unwanted positive feedback and noise.

APPLICATION INFORMATION (continued)

Typical Application Circuits

Difference Amplifier

The circuit in Figure 4 is a design example of classical difference amplifier. If  $R_4/R_3 = R_2/R_1$ , then  $V_{OUT} = (V_P - V_N) \times R_2/R_1 + V_{REF}$ .

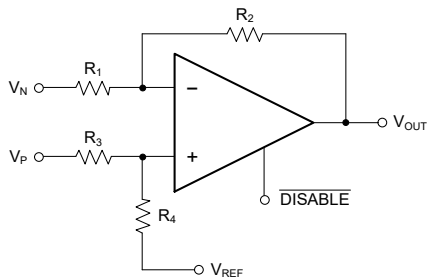

Figure 4. Difference Amplifier

High Input Impedance Difference Amplifier

The circuit in Figure 5 is a design example of high input impedance difference amplifier, the added amplifiers at the input are used to increase the input impedance and eliminate drawback of low input impedance in Figure 4.

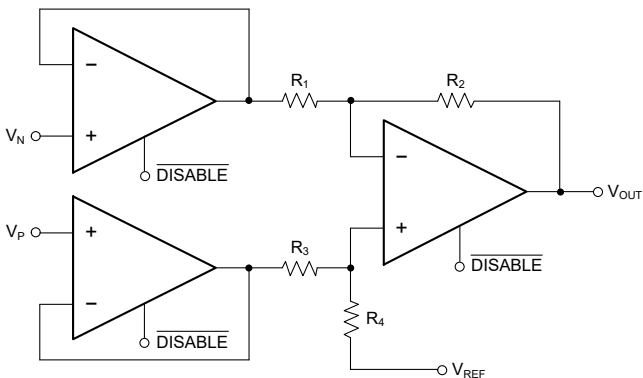

Figure 5. High Input Impedance Difference Amplifier

Active Low-Pass Filter

The circuit in Figure 6 is a design example of active low-pass filter, the DC gain is equal to  $-R_2/R_1$  and the -3dB corner frequency is equal to  $1/2\pi R_2 C$ . In this design, the filter bandwidth must be less than the bandwidth of the amplifier, the resistor values must be selected as low as possible to reduce ringing or oscillation generated by the parasitic parameters in PCB layout.

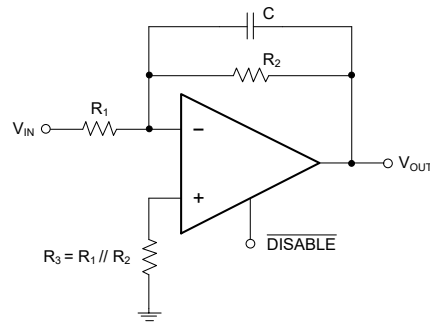

Figure 6. Active Low-Pass Filter

**REVISION HISTORY**

NOTE: Page numbers for previous revisions may differ from page numbers in the current version.

**Changes from Original (SEPTEMBER 2015) to REV.A**

**Page**

---

Changed from product preview to production data.....All

---

PACKAGE OUTLINE DIMENSIONS

TDFN-2x2-6L

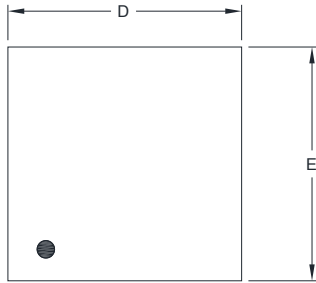

TOP VIEW

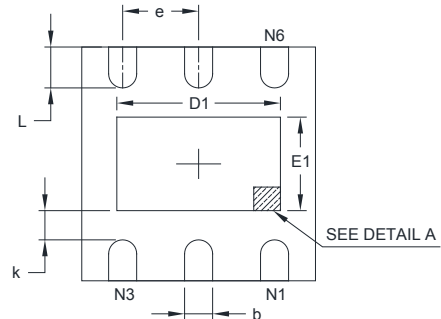

BOTTOM VIEW

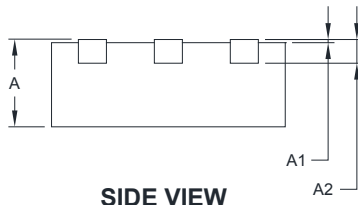

SIDE VIEW

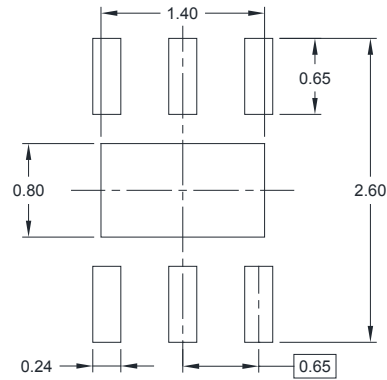

RECOMMENDED LAND PATTERN (Unit: mm)

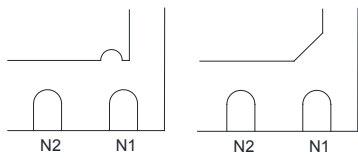

DETAIL A

Pin #1 ID and Tie Bar Mark Options

NOTE: The configuration of the Pin #1 identifier is optional, but must be located within the zone indicated.

Symbol	Dimensions In Millimeters		Dimensions In Inches	
	MIN	MAX	MIN	MAX
A	0.700	0.800	0.028	0.031
A1	0.000	0.050	0.000	0.002
A2	0.203 REF		0.008 REF	
D	1.900	2.100	0.075	0.083
D1	1.100	1.450	0.043	0.057
E	1.900	2.100	0.075	0.083
E1	0.600	0.850	0.024	0.034
k	0.200 MIN		0.008 MIN	
b	0.180	0.300	0.007	0.012
e	0.650 TYP		0.026 TYP	
L	0.250	0.450	0.010	0.018

# PACKAGE INFORMATION

## TAPE AND REEL INFORMATION

### REEL DIMENSIONS

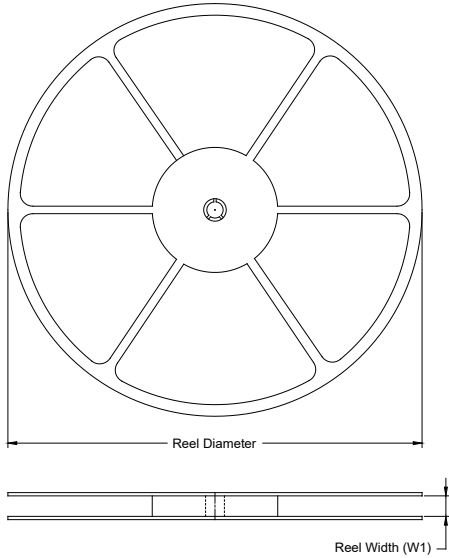

### TAPE DIMENSIONS

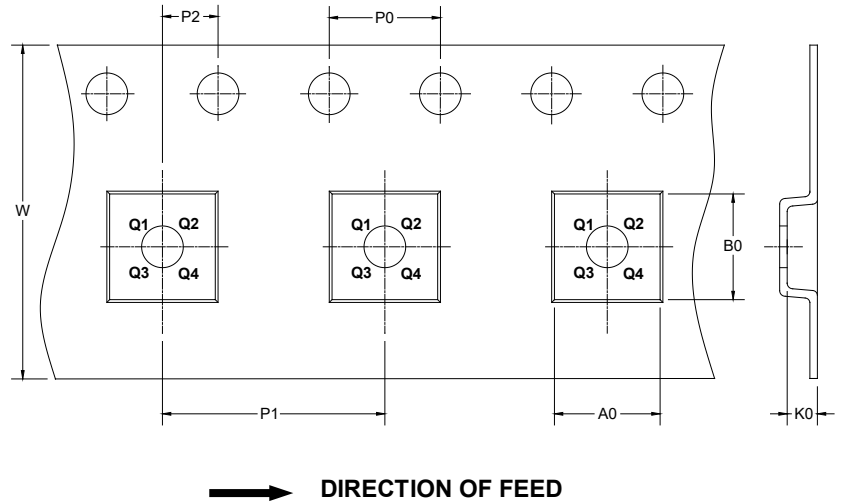

NOTE: The picture is only for reference. Please make the object as the standard.

### KEY PARAMETER LIST OF TAPE AND REEL

Package Type	Reel Diameter	Reel Width W1 (mm)	A0 (mm)	B0 (mm)	K0 (mm)	P0 (mm)	P1 (mm)	P2 (mm)	W (mm)	Pin1 Quadrant
TDFN-2×2-6L	7"	9.5	2.30	2.30	1.10	4.0	4.0	2.0	8.0	Q1

100001

# PACKAGE INFORMATION

## CARTON BOX DIMENSIONS

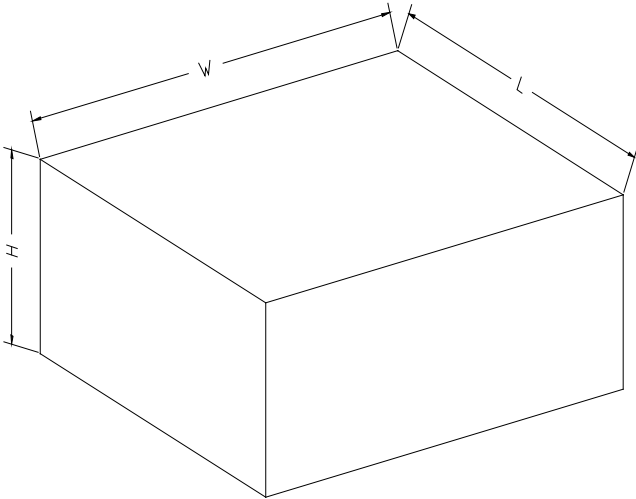

NOTE: The picture is only for reference. Please make the object as the standard.

## KEY PARAMETER LIST OF CARTON BOX

Reel Type	Length (mm)	Width (mm)	Height (mm)	Pizza/Carton
7" (Option)	368	227	224	8
7"	442	410	224	18

DD0002