

GENERAL DESCRIPTION

The SGM3836D is designed for powering AMOLED displays which require V_{AVDD} , V_{ELVDD} and V_{ELVSS} . The device integrates two boost converters, VO1 for V_{ELVDD} and VO3 for V_{AVDD} , and an inverting buck-boost converter VO2 for V_{ELVSS} . Output voltages of all the three converters can be programmed in digital steps through the digital interface control pin (CTRL).

The SGM3836D is available in a Green TQFN-3×3-16L package. It operates over an ambient temperature range of -40°C to +85°C.

FEATURES

- 2.9V to 4.5V Input Voltage Range
- Synchronous Boost Converter (ELVDD)
 - ◆ 4.6V to 5.0V Output Voltage with 100mV Steps
 - ◆ 4.6V Default Output Voltage
 - ◆ 1% Accuracy
 - ◆ Output Voltage Sensing Pin for Path Loss Compensation (FBS)
- Synchronous Inverting Buck-Boost Converter (ELVSS)
 - ◆ -5.4V to -1.4V Output Voltage with 100mV Steps
 - ◆ -4.0V Default Output Voltage
 - ◆ 1.1% Accuracy at -4.0V

- ELVDD & ELVSS Combined Output Current Capability
 - ◆ Up to 800mA at 4.6V/-2.5V ($V_{IN} = 3.1V$)
 - ◆ Up to 780mA at 4.6V/-2.7V ($V_{IN} = 3.1V$)
 - ◆ Up to 750mA at 4.6V/-3.0V ($V_{IN} = 3.1V$)
 - ◆ Up to 630mA at 4.6V/-4.0V ($V_{IN} = 3.1V$)
 - ◆ Up to 510mA at 4.6V/-5.4V ($V_{IN} = 3.1V$)
- Synchronous Boost Converter (AVDD)
 - ◆ 5.8V to 7.9V Output Voltage with 300mV Steps
 - ◆ 6.7V Default Output Voltage
 - ◆ 1% Accuracy
 - ◆ 100mA Output Current Capability
- V_{IN} and V_{OUT} Bi-Directional Isolation
- Short Circuit Protection (SCP)
- Overload Protection
- Thermal Shutdown
- V_{ELVSS} Start-Up Delay: 10ms
- Short Circuit and OLP Detect Time: 1ms
- Available in a Green TQFN-3×3-16L Package

APPLICATIONS

Smartphones & Tablets
Active Matrix OLED Displays

TYPICAL APPLICATION

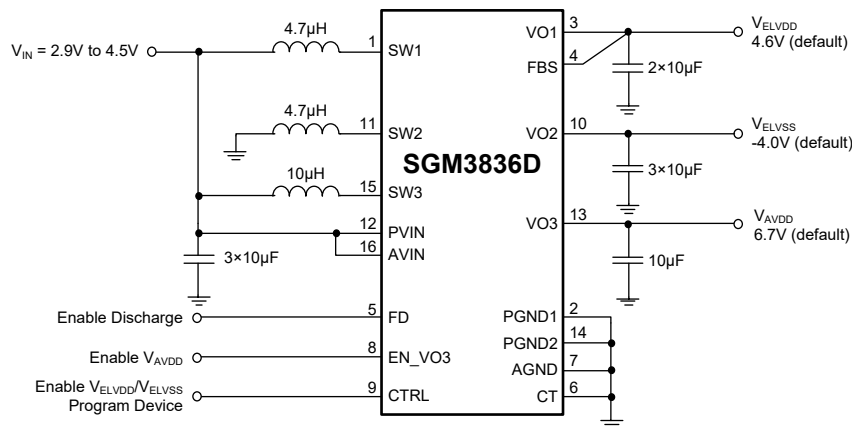

Figure 1. Typical Application Circuit

PACKAGE/ORDERING INFORMATION

MODEL	PACKAGE DESCRIPTION	SPECIFIED TEMPERATURE RANGE	ORDERING NUMBER	PACKAGE MARKING	PACKING OPTION
SGM3836D	TQFN-3×3-16L	-40°C to +85°C	SGM3836DYTQ16G/TR	3836DTQ XXXXX	Tape and Reel, 4000

MARKING INFORMATION

NOTE: XXXXX = Date Code and Vendor Code.

XXXXX

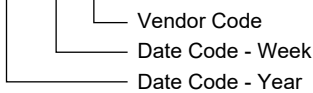

Green (RoHS & HSF): SG Micro Corp defines "Green" to mean Pb-Free (RoHS compatible) and free of halogen substances. If you have additional comments or questions, please contact your SGMICRO representative directly.

ABSOLUTE MAXIMUM RATINGS

PVIN, AVIN, EN_VO3, CTRL, CT, FD, SW1, VO1, FBS Voltages ⁽¹⁾	-0.3V to 6V
SW3, VO3 Voltages ⁽¹⁾	-0.3V to 10V
VO2 Voltage ⁽¹⁾	-6.5V to 0.3V
SW2 Voltage ⁽¹⁾	-6.5V to 5.5V
Package Thermal Resistance	
TQFN-3×3-16L, θ_{JA}	45°C/W
Junction Temperature	+150°C
Storage Temperature Range	-65°C to +150°C
Lead Temperature (Soldering, 10s)	+260°C
ESD Susceptibility	
HBM	3000V
CDM	1000V

RECOMMENDED OPERATING CONDITIONS

Operating Ambient Temperature Range	-40°C to +85°C
Operating Junction Temperature Range	-40°C to +125°C

NOTE:

1. All voltages are with respect to network ground pin.

OVERSTRESS CAUTION

Stresses beyond those listed in Absolute Maximum Ratings may cause permanent damage to the device. Exposure to absolute maximum rating conditions for extended periods may affect reliability. Functional operation of the device at any conditions beyond those indicated in the Recommended Operating Conditions section is not implied.

ESD SENSITIVITY CAUTION

This integrated circuit can be damaged if ESD protections are not considered carefully. SGMICRO recommends that all integrated circuits be handled with appropriate precautions. Failure to observe proper handling and installation procedures can cause damage. ESD damage can range from subtle performance degradation to complete device failure. Precision integrated circuits may be more susceptible to damage because even small parametric changes could cause the device not to meet the published specifications.

DISCLAIMER

SG Micro Corp reserves the right to make any change in circuit design, or specifications without prior notice.

PIN CONFIGURATION

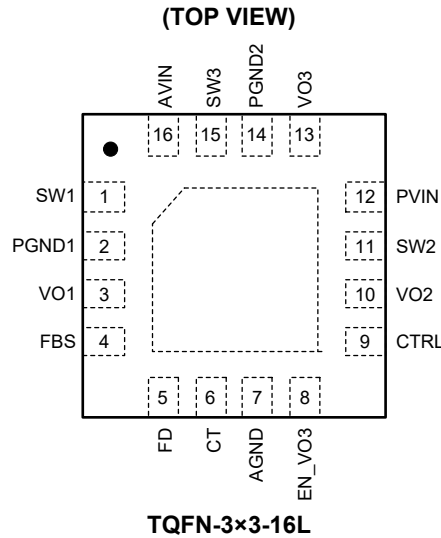

PIN DESCRIPTION

PIN	NAME	TYPE	DESCRIPTION
1	SW1	O	VO1 Boost Converter Switching Node.
2	PGND1	—	VO1 Boost Converter Power Ground Pin.
3	VO1	O	VO1 Boost Converter Output Pin.
4	FBS	I	VO1 Boost Converter Output Sense Input Pin.
5	FD	I	Output Discharge Enable/Disable during Shutdown. Logic high level enables the discharge and logic low level disables the discharge.
6	CT	I/O	VO2 Transition Time Control Pin.
7	AGND	—	Analog Ground Pin.
8	EN_VO3	I	VO3 Boost Converter Enable Pin.
9	CTRL	I	VO1/VO2 Converter Enable Pin.
10	VO2	O	VO2 Inverting Buck-Boost Converter Output Pin.
11	SW2	O	VO2 Inverting Buck-Boost Converter Switching Node.
12	PVIN	—	VO2 Inverting Buck-Boost Converter Power Supply Input Pin.
13	VO3	O	VO3 Boost Converter Output Pin.
14	PGND2	—	VO3 Boost Converter Power Ground Pin.
15	SW3	O	VO3 Boost Converter Switching Node.
16	AVIN	—	Analog Input Pin.
Exposed Pad		—	Connect this pad to AGND, PGND1 and PGND2.

NOTE: I: input; O: output; I/O: input or output.

ELECTRICAL CHARACTERISTICS

(At $T_J = +25^\circ\text{C}$, $V_{IN} = 3.7\text{V}$, Full = -40°C to $+85^\circ\text{C}$, $V_{CTRL} = V_{EN_VO3} = V_{IN}$, $V_{ELVDD} = 4.6\text{V}$, $V_{ELVSS} = -4.0\text{V}$, $V_{AVDD} = 6.7\text{V}$, unless otherwise noted.)

PARAMETER	SYMBOL	CONDITIONS	TEMP	MIN	TYP	MAX	UNITS
Supply Current and Thermal Protection							
Input Voltage Range	V_{IN}		Full	2.9		4.5	V
Shutdown Current into V_{IN}	I_{SD}	$V_{CTRL} = V_{EN_VO3} = \text{GND}$, $V_{FD} = \text{GND}$ or $V_{FD} = 3.7\text{V}$	$+25^\circ\text{C}$		0.2	1	μA
Under-Voltage Lockout Threshold (AVIN)	V_{IT-}	V_{IN} falling	$+25^\circ\text{C}$	2.35			V
	V_{IT+}	V_{IN} rising	$+25^\circ\text{C}$			2.8	V
Thermal Shutdown Temperature		Junction temperature rising			135		$^\circ\text{C}$
Thermal Shutdown Hysteresis		Junction temperature falling			10		$^\circ\text{C}$
Logic Signals (EN_VO3, CTRL, FD)							
Logic High Level Voltage	V_H	$V_{IN} = 2.9\text{V}$ to 4.5V	Full	1.2			V
Logic Low Level Voltage	V_L	$V_{IN} = 2.9\text{V}$ to 4.5V	Full			0.4	V
Pull-Down Resistor (EN_VO3, CTRL)	R_{DOWN}		$+25^\circ\text{C}$	350	550	750	$\text{k}\Omega$
Boost Converter ($V_{VO1} = V_{ELVDD}$)							
Positive Output 1 Voltage	V_{VO1}	$V_{VO1} = 4.6\text{V}$, no load	$+25^\circ\text{C}$	4.6	4.6	5.0	V
Positive Output 1 Voltage Variation			$+25^\circ\text{C}$	-1.0		1.0	%
			Full	-1.4		1.4	
SW1 MOSFET On-Resistance	$R_{DS(ON)1}$	$I_{DS} = 100\text{mA}$	$+25^\circ\text{C}$		120		$\text{m}\Omega$
SW1 MOSFET Rectifier On-Resistance	$R_{DS(ON)2}$	$I_{DS} = 100\text{mA}$	$+25^\circ\text{C}$		220		
SW1 Switch Current Limit	I_{SW1}	Inductor valley current	$+25^\circ\text{C}$	1.65	1.90	2.10	A
SW1 Switching Frequency	f_{SW1}	$I_{VO1} = 100\text{mA}$	$+25^\circ\text{C}$	1.35	1.50	1.70	MHz
Short Circuit Threshold in Operation	$V_{VO1(SCP)}$	Percentage of nominal V_{VO1}	$+25^\circ\text{C}$		90		%
Threshold of Output Sense with VO1	V_{TVO1}	$V_{VO1} - V_{FBS}$ increasing	$+25^\circ\text{C}$		300		mV
Threshold of Output Sense with FBS	V_{TFBS}	$V_{VO1} - V_{FBS}$ decreasing	$+25^\circ\text{C}$		200		mV
VO1 and FBS Leakage, No Discharge	I_{LEAK_VO1}	$V_{FD} = \text{GND}$, $V_{CTRL} = \text{GND}$	$+25^\circ\text{C}$		0.8	2	μA
Pull-Down Resistance of FBS	R_{FBS}		$+25^\circ\text{C}$		4		$\text{M}\Omega$
VO1 Discharge Resistance	$R_{VO1(DCG)}$	$V_{CTRL} = \text{GND}$, $I_{VO1} = 1\text{mA}$	$+25^\circ\text{C}$		30		Ω
Line Regulation		$I_{VO1} = 100\text{mA}$, $V_{IN} = 2.9\text{V}$ to 4.5V	$+25^\circ\text{C}$		0.007		%/V
Load Regulation		$1\text{mA} \leq I_{VO1} \leq 600\text{mA}$	$+25^\circ\text{C}$		0.27		%/A
Buck-Boost Converter ($V_{VO2} = V_{ELVSS}$)							
Negative Output Voltage Range	V_{VO2}		$+25^\circ\text{C}$	-5.4	-4.0	-1.4	V
Negative Output Voltage Regulation		$V_{VO2} = -4.0\text{V}$, no load	$+25^\circ\text{C}$	-45		45	mV
			Full	-55		55	
SW2 MOSFET On-Resistance	$R_{DS(ON)3}$	$I_{DS} = 100\text{mA}$	$+25^\circ\text{C}$		150		$\text{m}\Omega$
SW2 MOSFET Rectifier On-Resistance	$R_{DS(ON)4}$	$I_{DS} = 100\text{mA}$	$+25^\circ\text{C}$		180		
SW2 Switch Current Limit	I_{SW2}	Inductor peak current	$+25^\circ\text{C}$	1.7	2.0	2.4	A
SW2 Switching Frequency	f_{SW2}	$I_{VO2} = 100\text{mA}$	$+25^\circ\text{C}$	1.35	1.50	1.70	MHz
Short Circuit Threshold in Operation	$V_{VO2(SCP)}$	Voltage rise from nominal V_{VO2}	$+25^\circ\text{C}$		500		mV
VO2 Negative Comparator at Start-Up			$+25^\circ\text{C}$		-700		
VO2 Leakage, No Discharge	I_{LEAK_VO2}	$V_{FD} = V_{CTRL} = \text{GND}$	$+25^\circ\text{C}$		0.2	1	μA
VO2 Discharge Resistance	$R_{VO2(DCG)}$	$V_{CTRL} = \text{GND}$, $I_{VO2} = 1\text{mA}$	$+25^\circ\text{C}$		150		Ω
CT Pin Output Impedance	R_{CT}		$+25^\circ\text{C}$		300		$\text{k}\Omega$
CT Pin Comparator	Comp _{CT}	V_{CT} rising	$+25^\circ\text{C}$		50		mV
Line Regulation		$I_{VO2} = 100\text{mA}$, $V_{IN} = 2.9\text{V}$ to 4.5V	$+25^\circ\text{C}$		0.003		%/V
Load Regulation		$1\text{mA} \leq I_{VO2} \leq 600\text{mA}$	$+25^\circ\text{C}$		0.37		%/A

ELECTRICAL CHARACTERISTICS (continued)

(At $T_J = +25^\circ\text{C}$, $V_{IN} = 3.7\text{V}$, Full = -40°C to $+85^\circ\text{C}$, $V_{CTRL} = V_{EN_VO3} = V_{IN}$, $V_{ELVDD} = 4.6\text{V}$, $V_{ELVSS} = -4.0\text{V}$, $V_{AVDD} = 6.7\text{V}$, unless otherwise noted.)

PARAMETER	SYMBOL	CONDITIONS	TEMP	MIN	TYP	MAX	UNITS
Boost Converter ($V_{VO3} = V_{AVDD}$)							
Positive Output 2 Voltage Range	V_{VO3}		$+25^\circ\text{C}$	5.8	6.7	7.9	V
Positive Output 2 Voltage Variation		$V_{VO3} = 6.7\text{V}$, no load	$+25^\circ\text{C}$	-1.0		1.0	%
			Full	-1.5		1.5	
SW3 MOSFET On-Resistance	$R_{DS(ON)5}$	$I_{DS} = 100\text{mA}$	$+25^\circ\text{C}$		550		m Ω
SW3 MOSFET Rectifier On-Resistance	$R_{DS(ON)6}$	$I_{DS} = 100\text{mA}$	$+25^\circ\text{C}$		1000		
SW3 Switch Current Limit	I_{SW3}	Inductor peak current	$+25^\circ\text{C}$	0.3	0.4	0.5	A
SW3 Switching Frequency	f_{SW3}	$I_{VO3} = 30\text{mA}$	$+25^\circ\text{C}$	1.35	1.50	1.70	MHz
Output Current Sensing	I_{OUT}		$+25^\circ\text{C}$		100		mA
Short Circuit Threshold in Operation	$V_{VO3(SCP)}$	Percentage of nominal V_{VO3}	$+25^\circ\text{C}$		90		%
VO3 Leakage, No Discharge	I_{LEAK_VO3}	$V_{FD} = \text{GND}$, $V_{EN_VO3} = \text{GND}$	$+25^\circ\text{C}$		2	3	μA
VO3 Discharge Resistance	$R_{VO3(DCG)}$	$V_{EN_VO3} = \text{GND}$, $I_{VO3} = 1\text{mA}$	$+25^\circ\text{C}$		30		Ω
Line Regulation		$I_{VO3} = 30\text{mA}$, $V_{IN} = 2.9\text{V}$ to 4.5V	$+25^\circ\text{C}$		0.013		%/V
Load Regulation		$1\text{mA} \leq I_{VO3} \leq 55\text{mA}$	$+25^\circ\text{C}$		0.4		%/A

TIMING REQUIREMENTS

PARAMETER	SYMBOL	MIN	TYP	MAX	UNITS
Short Circuit Timer					
VO1 Short Circuit Detection Time in Start-Up	$t_{VO1(SCP)}$		10		ms
VO1 Short Circuit Detection Time in Operation			1		
VO2 Short Circuit Detection Time in Start-Up	$t_{VO2(SCP)}$		10		
VO2 Short Circuit Detection Time in Operation			1		
VO3 Short Circuit Detection Time in Operation	$t_{VO3(SCP)}$		1		
VO3 Overload Detection Delay	$t_{D(OVERLOAD)}$		1		
VO2 Discharge Time after CTRL Goes High	$t_{D(DISCHARGE)}$		10		
CTRL Interface					
Initialization Time	t_{INIT}		300	400	μs
Shutdown Time Period	t_{OFF}	30	55	80	
Pulse High Level Time Period	t_{HIGH}	2	10	25	
Pulse Low Level Time Period	t_{LOW}	2	10	25	
Data Storage/Accept Time Period	t_{STORE}	30	55	80	

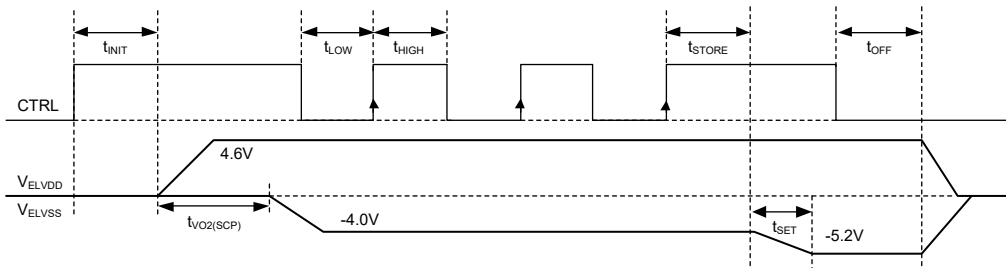
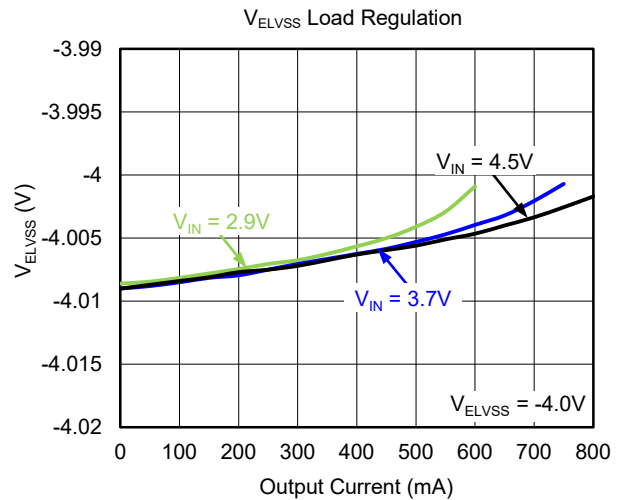
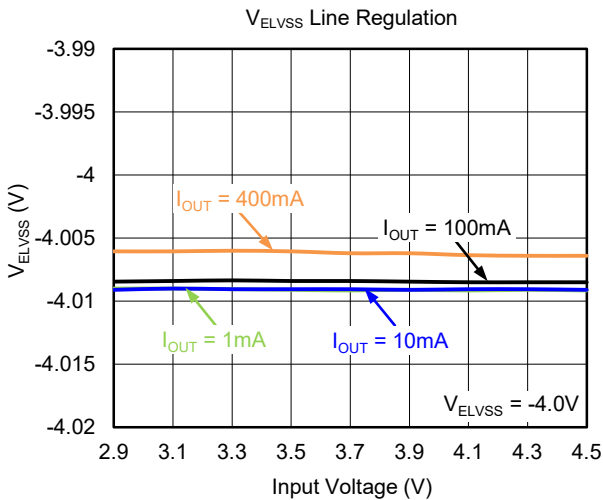
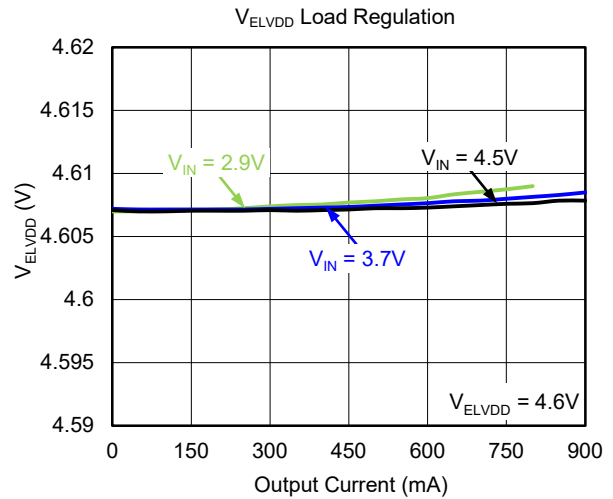
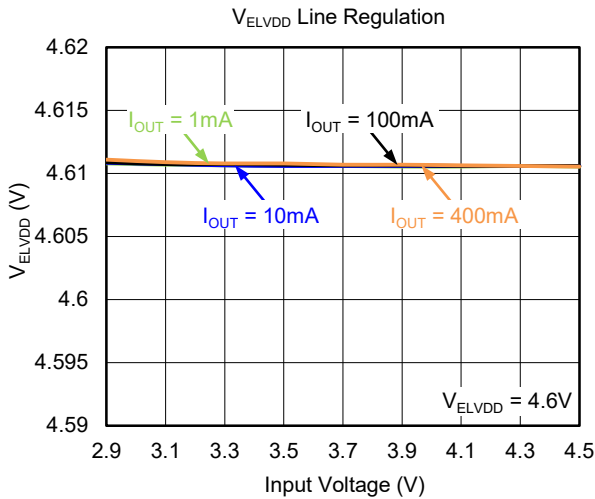
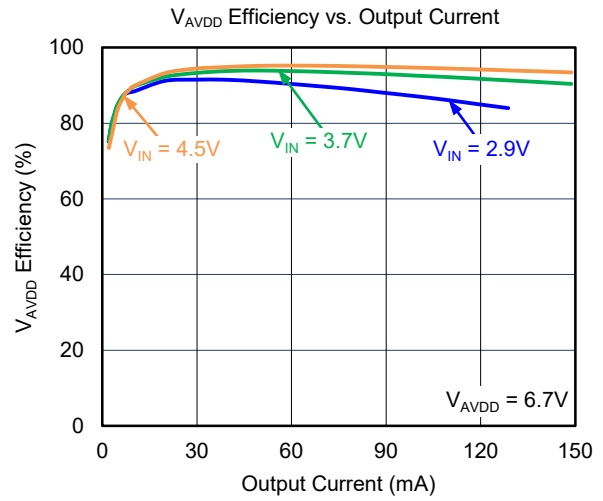
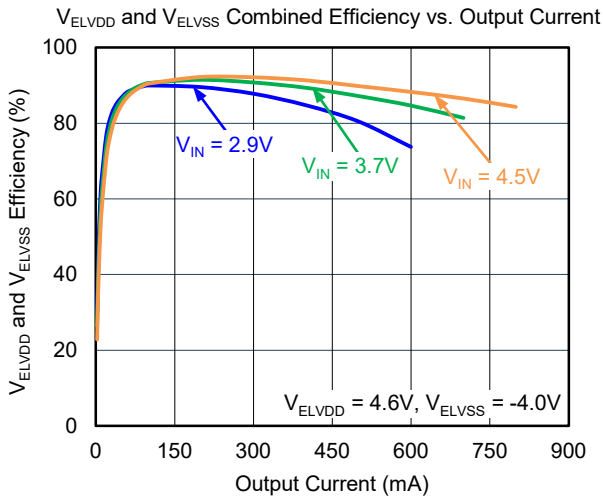

Figure 2. Timing Diagram

TYPICAL PERFORMANCE CHARACTERISTICS

At $T_J = +25^\circ\text{C}$, $V_{IN} = 3.7\text{V}$, unless otherwise noted.



TYPICAL PERFORMANCE CHARACTERISTICS (continued)

At $T_J = +25^\circ\text{C}$, $V_{IN} = 3.7\text{V}$, unless otherwise noted.

V_{AVDD} Line Regulation

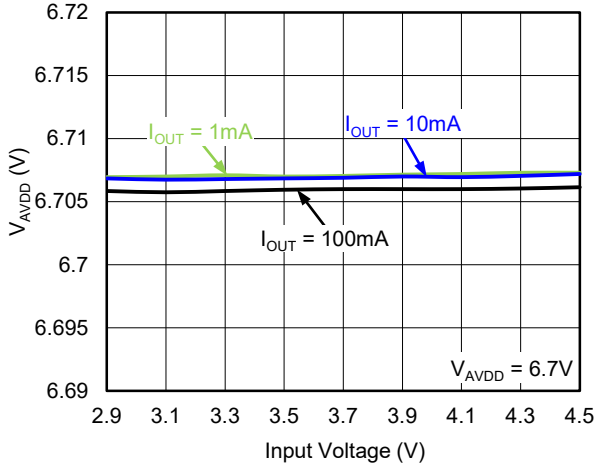

V_{AVDD} Load Regulation

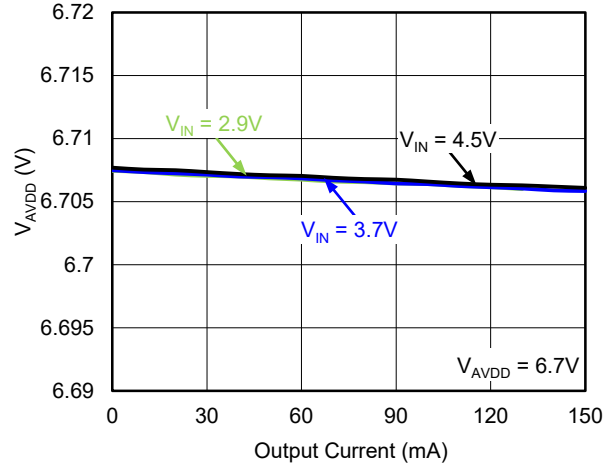

V_{ELVDD} and V_{ELVSS} Combined Maximum Output Current vs. Input Voltage

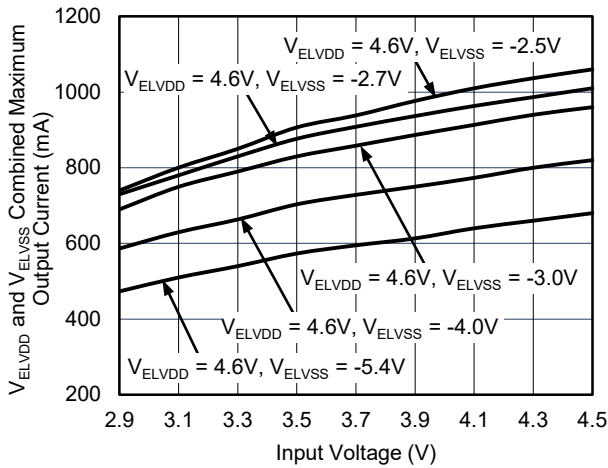

ELVDD (4.6V) Voltage Production Distribution

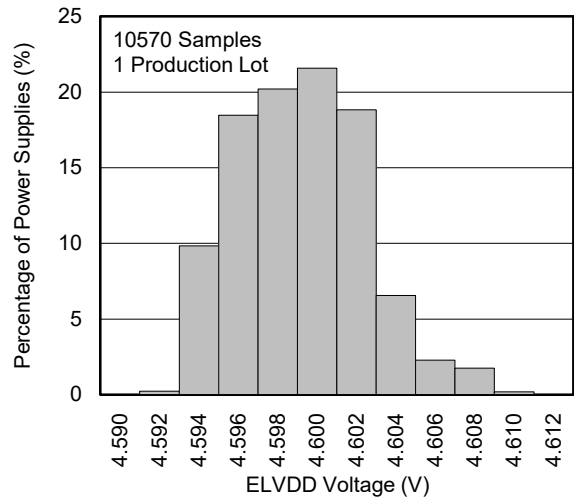

ELVSS (-4.0V) Voltage Production Distribution

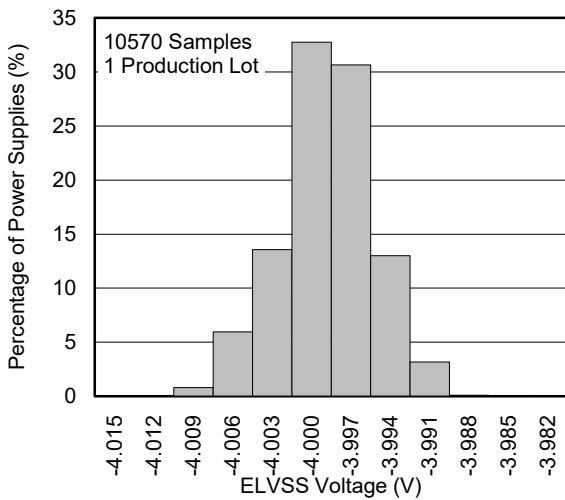

AVDD (6.7V) Voltage Production Distribution

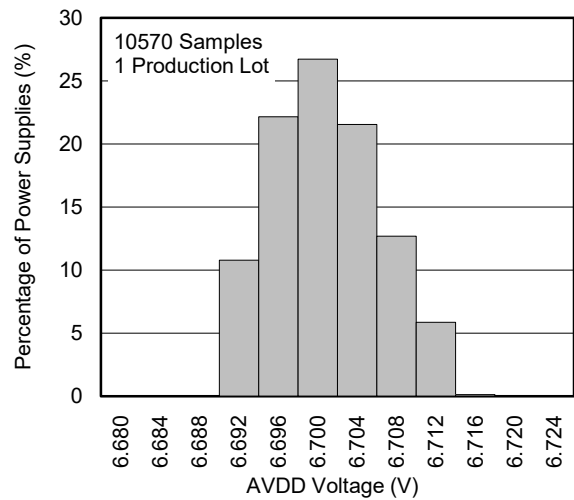

TYPICAL PERFORMANCE CHARACTERISTICS (continued)

At $T_J = +25^\circ\text{C}$, $V_{IN} = 3.7\text{V}$, unless otherwise noted.

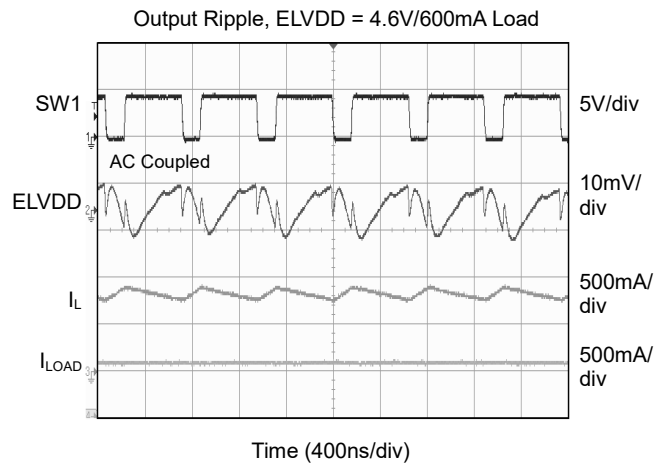
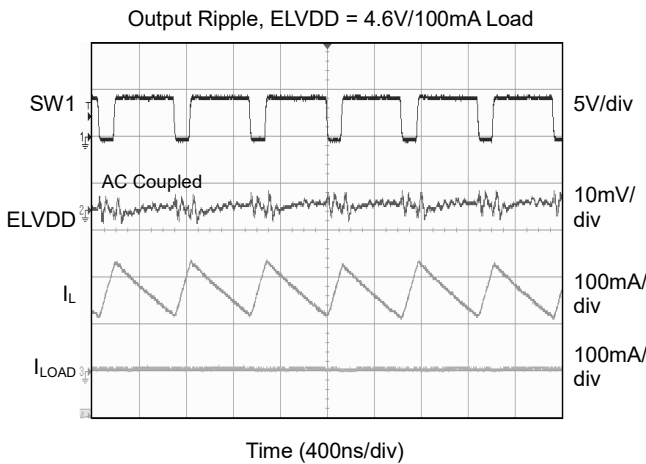
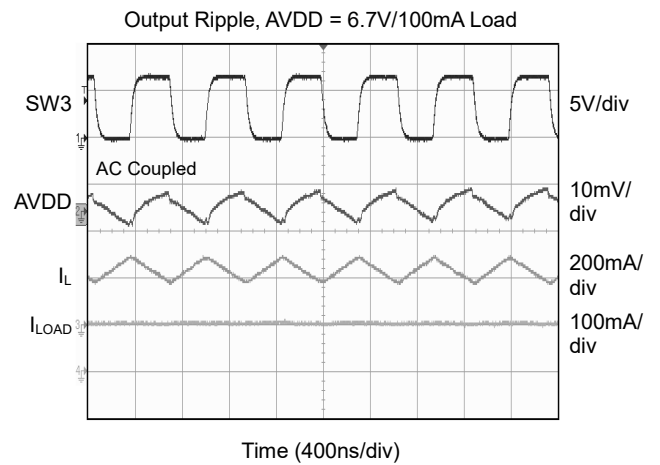
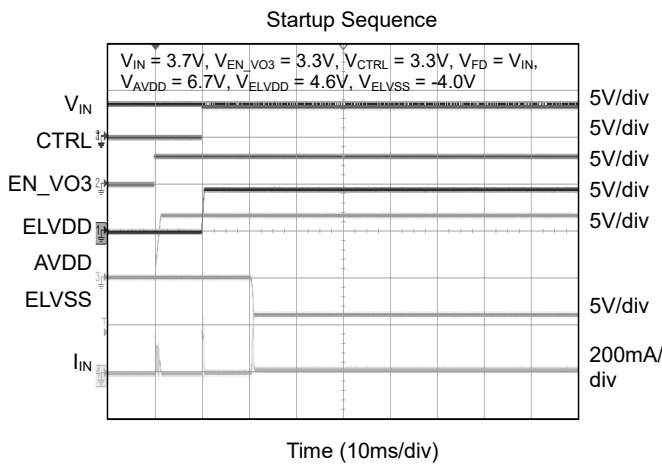
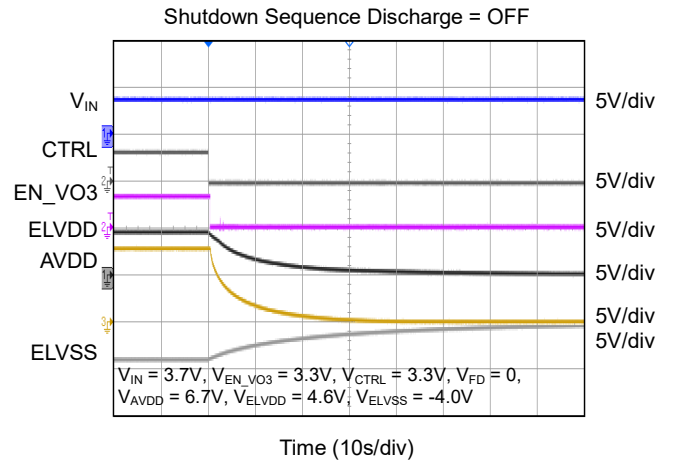
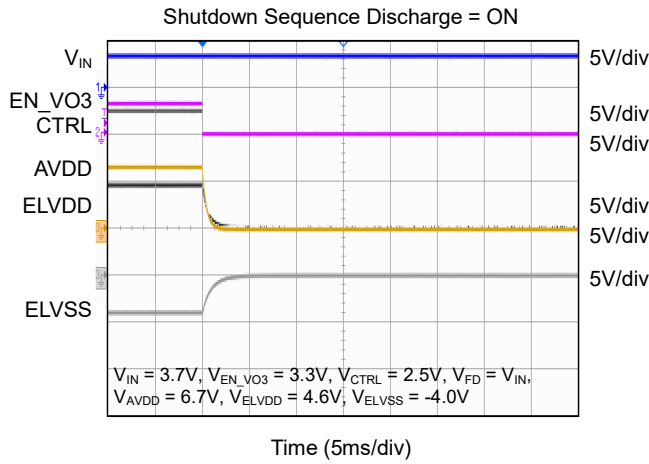

TYPICAL PERFORMANCE CHARACTERISTICS (continued)

At $T_J = +25^\circ\text{C}$, $V_{IN} = 3.7\text{V}$, unless otherwise noted.

Output Ripple, ELVSS = -4.0V/100mA Load

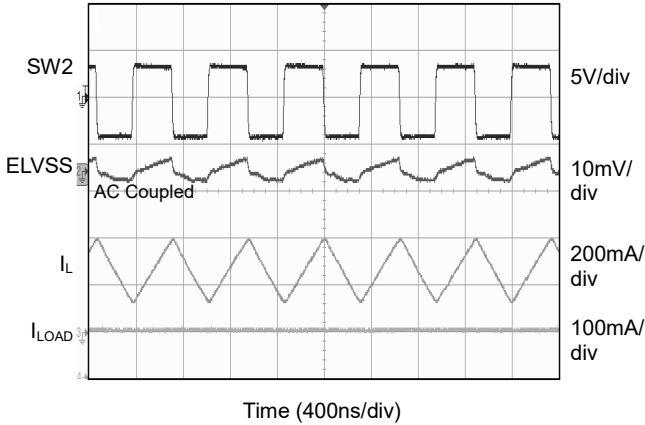

Output Ripple, ELVSS = -4.0V/600mA Load

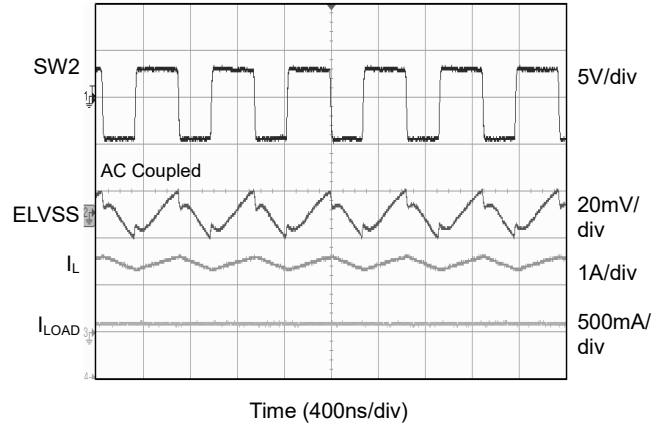

Line Transient No Load

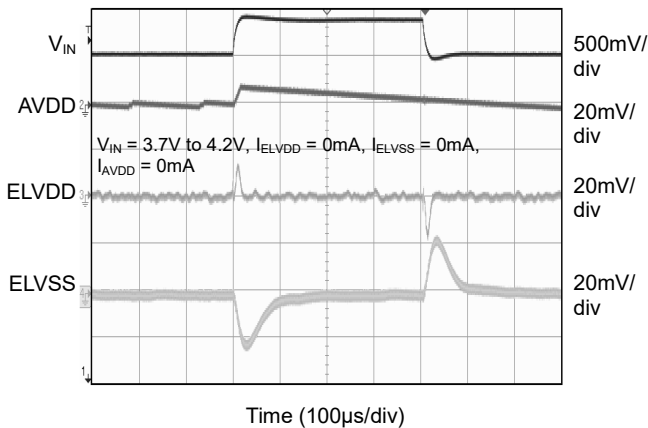

Line Transient Heavy Load

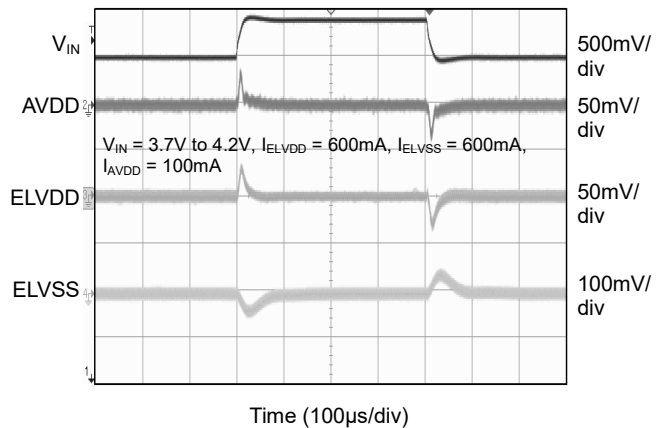

ELVDD Load Transient

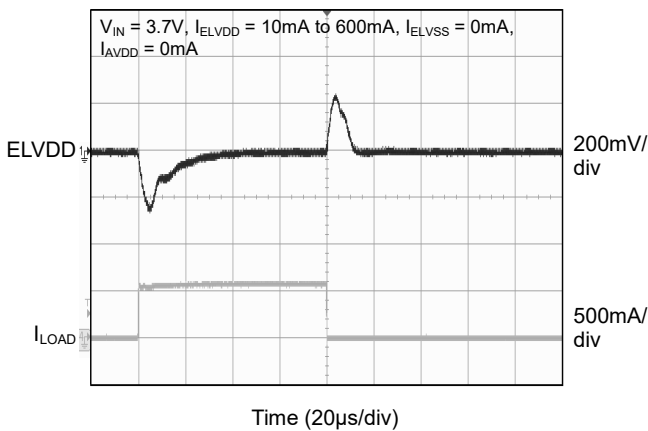

ELVSS Load Transient

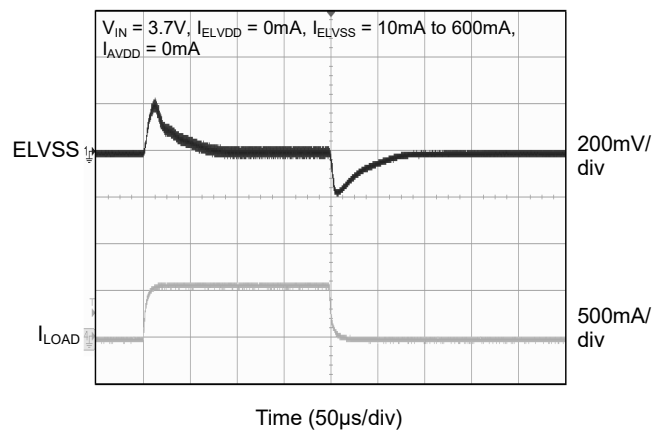

TYPICAL PERFORMANCE CHARACTERISTICS (continued)

At $T_J = +25^\circ\text{C}$, $V_{IN} = 3.7\text{V}$, unless otherwise noted.

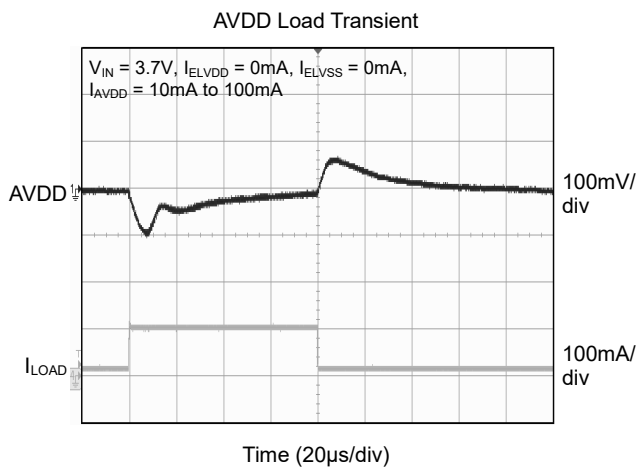

DETAILED DESCRIPTION

Table 1. Programming Table

Rising Edges	VO2 (V _{ELVSS})	Rising Edges	VO2 (V _{ELVSS})	Rising Edges	VO3 (V _{AVDD})	Rising Edges	Outputs Discharge	Rising Edges	VO2 Transition Time	Rising Edges	VO1 (V _{ELVDD})
0/no pulse	-4.0V	21	-3.4V	0/no pulse	6.7V	0/no pulse	controlled by FD pin	0/no pulse	controlled by CT pin	0/no pulse	4.6V
1	-5.4V	22	-3.3V	42	7.9V	50	ON	52	reserved	54	4.7V
2	-5.3V	23	-3.2V	43	7.6V	51	OFF	53	reserved	55	4.8V
3	-5.2V	24	-3.1V	44	7.3V					56	4.9V
4	-5.1V	25	-3.0V	45	7.0V					57	5.0V
5	-5.0V	26	-2.9V	46	6.7V						
6	-4.9V	27	-2.8V	47	6.4V						
7	-4.8V	28	-2.7V	48	6.1V						
8	-4.7V	29	-2.6V	49	5.8V						
9	-4.6V	30	-2.5V								
10	-4.5V	31	-2.4V								
11	-4.4V	32	-2.3V								
12	-4.3V	33	-2.2V								
13	-4.2V	34	-2.1V								
14	-4.1V	35	-2.0V								
15	-4.0V	36	-1.9V								
16	-3.9V	37	-1.8V								
17	-3.8V	38	-1.7V								
18	-3.7V	39	-1.6V								
19	-3.6V	40	-1.5V								
20	-3.5V	41	-1.4V								

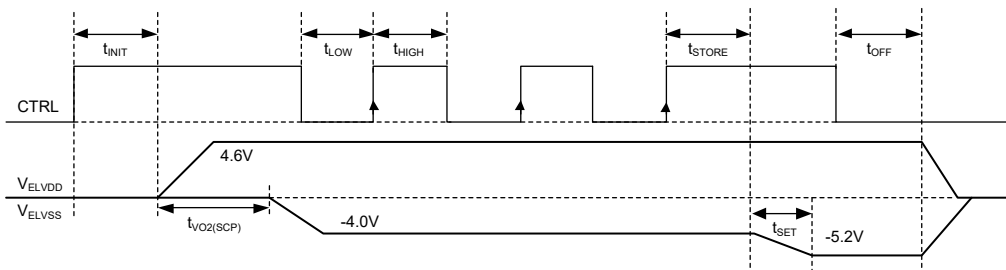

Figure 3. SGM3836D Programming V_{ELSS}

DETAILED DESCRIPTION (continued)

Table 2. Output Current Capacity (mA)

V _{IN} (V)	V _{O2} (V _{O1} = 4.6V)				
	-2.5V	-2.7V	-3.0V	-4.0V	-5.4V
2.9	740	730	690	590	470
3.1	800	780	750	630	510
3.3	850	830	790	660	540
3.5	905	875	830	700	570
3.7	940	910	860	730	595
3.9	975	940	890	750	615
4.1	1010	960	910	770	640
4.3	1035	985	940	800	660
4.5	1060	1010	960	820	680

ADDITIONAL TYPICAL APPLICATION

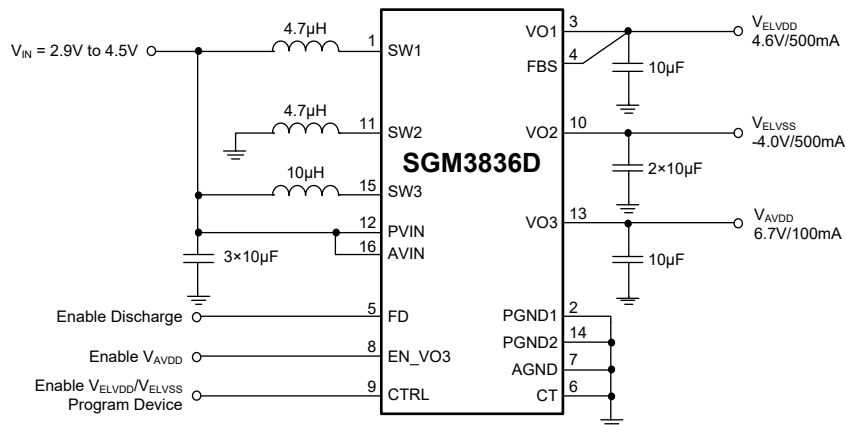

Figure 4. Typical Application Circuit for Load Current Lower than 500mA

REVISION HISTORY

NOTE: Page numbers for previous revisions may differ from page numbers in the current version.

DECEMBER 2019 – REV.A to REV.A.1	Page
Changed Detailed Description section	14
Changes from Original (AUGUST 2019) to REV.A	
Changed from product preview to production data	All

PACKAGE INFORMATION

PACKAGE OUTLINE DIMENSIONS

TQFN-3×3-16L

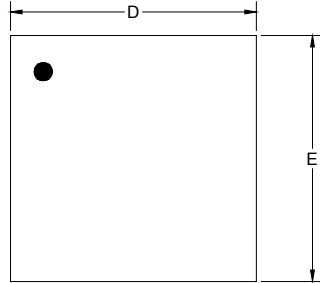

TOP VIEW

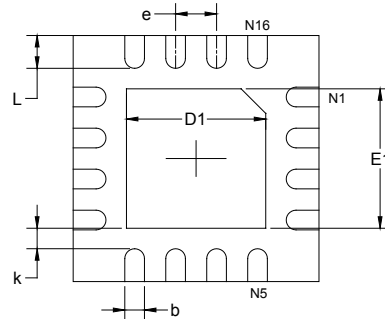

BOTTOM VIEW

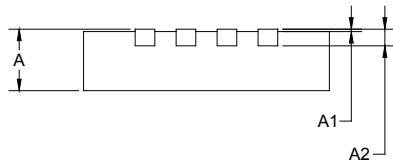

SIDE VIEW

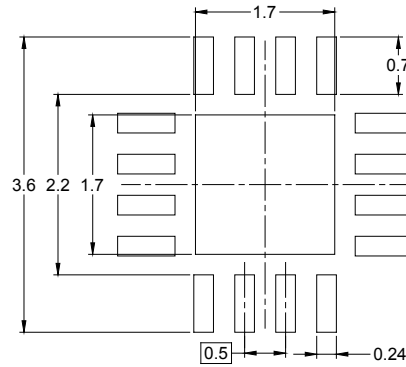

RECOMMENDED LAND PATTERN (Unit: mm)

Symbol	Dimensions In Millimeters		Dimensions In Inches	
	MIN	MAX	MIN	MAX
A	0.700	0.800	0.028	0.031
A1	0.000	0.050	0.000	0.002
A2	0.203 REF		0.008 REF	
D	2.900	3.100	0.114	0.122
D1	1.600	1.800	0.063	0.071
E	2.900	3.100	0.114	0.122
E1	1.600	1.800	0.063	0.071
k	0.200 MIN		0.008 MIN	
b	0.180	0.300	0.007	0.012
e	0.500 TYP		0.020 TYP	
L	0.300	0.500	0.012	0.020

PACKAGE INFORMATION

TAPE AND REEL INFORMATION

REEL DIMENSIONS

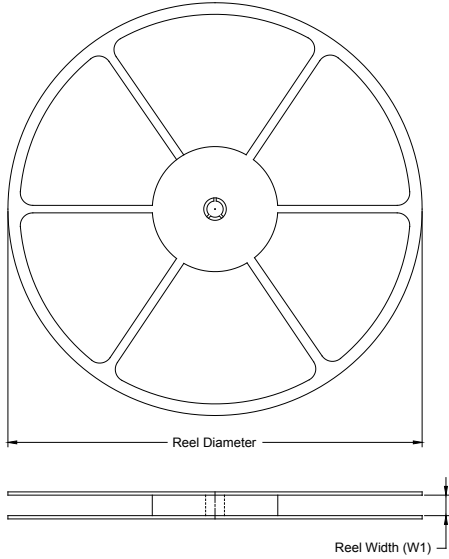

TAPE DIMENSIONS

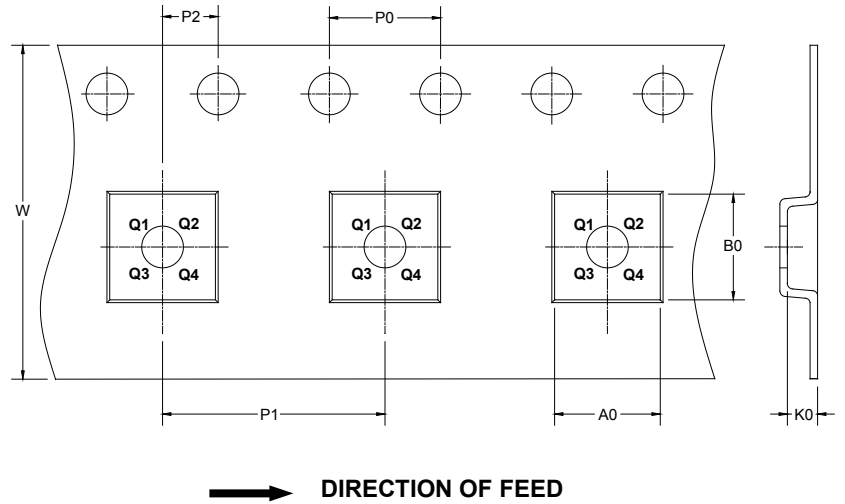

NOTE: The picture is only for reference. Please make the object as the standard.

KEY PARAMETER LIST OF TAPE AND REEL

Package Type	Reel Diameter	Reel Width W1 (mm)	A0 (mm)	B0 (mm)	K0 (mm)	P0 (mm)	P1 (mm)	P2 (mm)	W (mm)	Pin1 Quadrant
TQFN-3×3-16L	13"	12.4	3.35	3.35	1.13	4.0	8.0	2.0	12.0	Q2

DD0001

PACKAGE INFORMATION

CARTON BOX DIMENSIONS



NOTE: The picture is only for reference. Please make the object as the standard.

KEY PARAMETER LIST OF CARTON BOX

Reel Type	Length (mm)	Width (mm)	Height (mm)	Pizza/Carton
13"	386	280	370	5

DD0002