



# SGM6031

## 400nA Ultra-Low Power, Buck Converter with 200mA Output Current

### GENERAL DESCRIPTION

The SGM6031 family is a 200mA, 1.4MHz synchronous Buck DC/DC converter with 400nA ultra-low quiescent current, which is ideal for powering ultra-low power applications with special needs.

The SGM6031 operation voltage range is from 1.8V to 5.5V, allowing the use of a regulated 5V input. The SGM6031 is available in both adjustable and fixed output voltage versions. The output voltage of SGM6031 can be programmed by an external resistor divider in adjustable version.

The SGM6031 delivers an output current of 200mA with a peak inductor current of 430mA. Besides, the SGM6031 series has the under-voltage lockout (UVLO) function. It is disabled when the voltage on VIN reaches the UVLO condition. The SGM6031's under-voltage lockout level is continuously monitored. Only the inductor, C<sub>IN</sub> and C<sub>OUT</sub> capacitors are needed as external components to make a Buck DC/DC converter solution.

The SGM6031 is available in a Green UTDFN-1.5×2-6L package.

### FEATURES

- **Input Voltage Range: 1.8V to 5.5V**
- **Fixed Output Voltages: 1.0V, 1.2V, 1.5V, 1.8V, 2.5V, 2.8V, 3.0V and 3.3V**
- **Adjustable Output Voltages: 1.0V to 3.3V**
- **High Efficiency at Low Output Currents:  
Up to 90% with I<sub>OUT</sub> = 0.1mA**
- **Ultra-Low Power Buck Converter**
- **200mA (MAX) Output Current**
- **400nA (TYP) Quiescent Current**
- **100% Duty Cycle (Pass Mode)**
- **-40°C to +85°C Operating Temperature Range**
- **Available in a Green UTDFN-1.5×2-6L Package**

### APPLICATIONS

Energy Harvest Devices  
Ultra-Low Power Applications  
Low-Power Wireless Monitoring  
Backup Power Supply Circuits  
2-Cell and 3-Cell Alkaline-Powered Systems  
Portable Game Consoles  
Wearable Devices  
Thermal Electric Generator Harvesting  
Wireless Sensor Networks  
Smart Building Controls  
Environmental Monitoring

**PACKAGE/ORDERING INFORMATION**

MODEL	V <sub>OUT</sub> (V)	PACKAGE DESCRIPTION	ORDERING NUMBER	PACKAGE MARKING	PACKING OPTION
SGM6031-1.0	1.0	UTDFN-1.5×2-6L	SGM6031-1.0YUDT6G/TR	GJC XXX	Tape and Reel, 3000
SGM6031-1.2	1.2	UTDFN-1.5×2-6L	SGM6031-1.2YUDT6G/TR	GJD XXX	Tape and Reel, 3000
SGM6031-1.5	1.5	UTDFN-1.5×2-6L	SGM6031-1.5YUDT6G/TR	GJE XXX	Tape and Reel, 3000
SGM6031-1.8	1.8	UTDFN-1.5×2-6L	SGM6031-1.8YUDT6G/TR	GJF XXX	Tape and Reel, 3000
SGM6031-2.5	2.5	UTDFN-1.5×2-6L	SGM6031-2.5YUDT6G/TR	GK0 XXX	Tape and Reel, 3000
SGM6031-2.8	2.8	UTDFN-1.5×2-6L	SGM6031-2.8YUDT6G/TR	GK1 XXX	Tape and Reel, 3000
SGM6031-3.0	3.0	UTDFN-1.5×2-6L	SGM6031-3.0YUDT6G/TR	GX0 XXX	Tape and Reel, 3000
SGM6031-3.3	3.3	UTDFN-1.5×2-6L	SGM6031-3.3YUDT6G/TR	GK2 XXX	Tape and Reel, 3000
SGM6031-ADJ	ADJ	UTDFN-1.5×2-6L	SGM6031-ADJYUDT6G/TR	GLF XXX	Tape and Reel, 3000

**MARKING INFORMATION**

NOTE: XXX = Date Code.

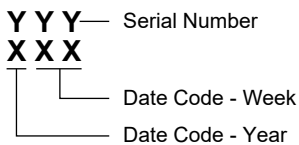

Green (RoHS & HSF): SG Micro Corp defines "Green" to mean Pb-Free (RoHS compatible) and free of halogen substances. If you have additional comments or questions, please contact your SGMICRO representative directly.

**ABSOLUTE MAXIMUM RATINGS**

Input Voltage Range on VIN, EN, VOUT, FB, SW	-0.3V to 6V
Peak Currents VIN, VOUT	510mA
Typical Thermal Resistance	
UTDFN-1.5×2-6L, $\theta_{JA}$	130°C/W
Junction Temperature	+150°C
Storage Temperature Range	-65°C to +150°C
Lead Temperature (Soldering, 10s)	+260°C
ESD Susceptibility	
HBM	7000V
MM	400V
CDM	1000V

**RECOMMENDED OPERATING CONDITIONS**

Input Voltage Range	1.8V to 5.5V
Input Capacitance, C <sub>IN</sub>	22µF (MIN)
Output Capacitance, C <sub>OUT</sub>	10µF (MIN), 22µF (TYP)
Inductance, L	4.7µH (MIN)
Operating Ambient Temperature Range	-40°C to +85°C
Operating Junction Temperature Range	-40°C to +125°C

**OVERSTRESS CAUTION**

Stresses beyond those listed in Absolute Maximum Ratings may cause permanent damage to the device. Exposure to absolute maximum rating conditions for extended periods may affect reliability. Functional operation of the device at any conditions beyond those indicated in the Recommended Operating Conditions section is not implied.

**ESD SENSITIVITY CAUTION**

This integrated circuit can be damaged if ESD protections are not considered carefully. SGMICRO recommends that all integrated circuits be handled with appropriate precautions. Failure to observe proper handling and installation procedures can cause damage. ESD damage can range from subtle performance degradation to complete device failure. Precision integrated circuits may be more susceptible to damage because even small parametric changes could cause the device not to meet the published specifications.

**DISCLAIMER**

SG Micro Corp reserves the right to make any change in circuit design, or specifications without prior notice.

**PIN CONFIGURATION**

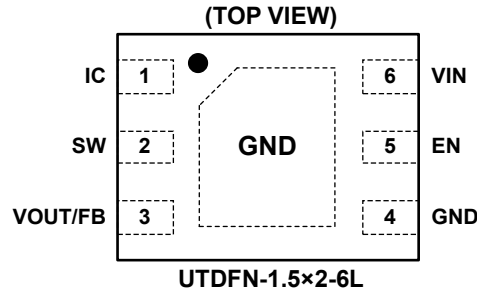

**PIN DESCRIPTION**

PIN	NAME	FUNCTION
1	IC	For Internal Connection.
2	SW	Switching Node. Connect to output inductor.
3	VOUT	Buck Regulator Output.
	FB	Feedback Input (adjustable voltage version only). The voltage at this pin is regulated to 1.0V. Connect to the resistor divider between output and ground to set output voltage.
4	GND	Ground. Power and IC ground. All signals are referenced to this pin.
5	EN	Enable Input. Input logic high to enable this circuit and logic low to shut down. Do not leave this pin unconnected. EN is recommended to be effective 10ms later than VIN.
6	VIN	Input Voltage. Connect to input power source.
Exposed Pad	GND	Connect to GND.

**ELECTRICAL CHARACTERISTICS**(V<sub>IN</sub> = 3.6V, V<sub>OUT</sub> = 1.2V. Full = -40°C to +85°C, typical values are at T<sub>A</sub> = +25°C, unless otherwise noted.)

PARAMETER	SYMBOL	CONDITIONS	TEMP	MIN	TYP	MAX	UNITS
<b>Quiescent Current</b>							
Buck Enabled State	I <sub>Q</sub>	V <sub>IN</sub> = 1.8V, no load, no switching	+25°C		400	700	nA
<b>Output</b>							
Feedback Voltage	V <sub>FB</sub>		+25°C	0.98	1.0	1.02	V
Output Accuracy			+25°C	-2		2	%
			Full	-3		3	
Output Line Regulation		V <sub>IN</sub> = 1.8V to 5.5V, I <sub>OUT</sub> = 100μA	+25°C		0.3		%/V
Output Load Regulation		I <sub>OUT</sub> = 100μA to 200mA	+25°C		0.002		%/mA
Output Ripple		I <sub>OUT</sub> = 1mA	+25°C		15		mV <sub>PP</sub>
<b>Power Switch</b>							
High-side Switch On-Resistance	R <sub>DSON</sub>		+25°C		510	620	mΩ
Low-side Switch On-Resistance			+25°C		530		
Cycle-by-Cycle Current Limit	I <sub>LIM</sub>		+25°C	300	430	510	mA
Maximum Switching Frequency	f <sub>SW</sub>		+25°C		1.4		MHz
<b>Input</b>							
Input Under Voltage Protection	V <sub>IN_UVLO</sub>	V <sub>IN</sub> falling	+25°C	1.19	1.3		V
<b>EN</b>							
Voltage for EN High Setting	V <sub>IH</sub>		Full	1.1			V
Voltage for EN Low Setting	V <sub>IL</sub>		Full			0.4	
<b>Thermal Shutdown</b>							
Thermal Shutdown	T <sub>TSD</sub>				160		°C
Thermal Shutdown Hysteresis	T <sub>HYS</sub>				20		°C

TYPICAL PERFORMANCE CHARACTERISTICS

T<sub>A</sub> = +25°C, unless otherwise noted.

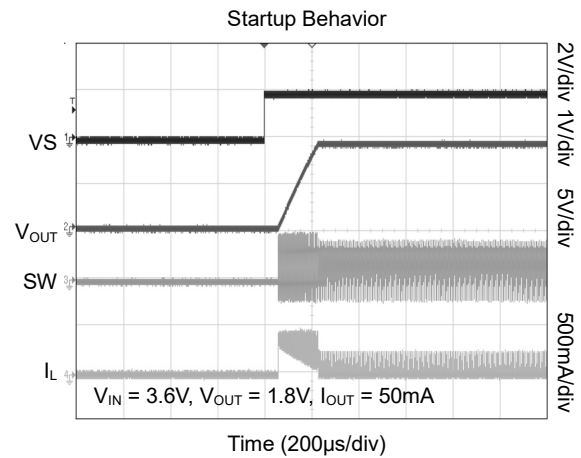
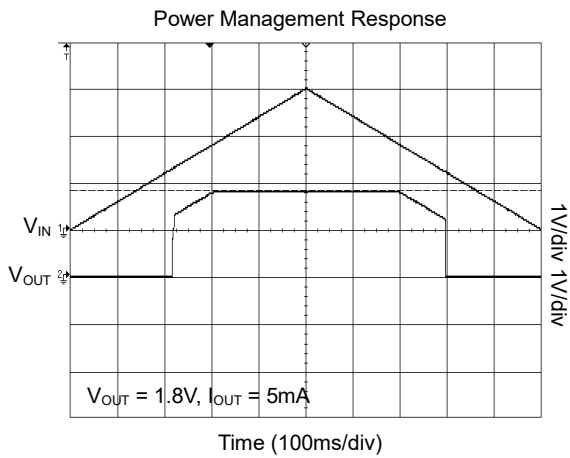
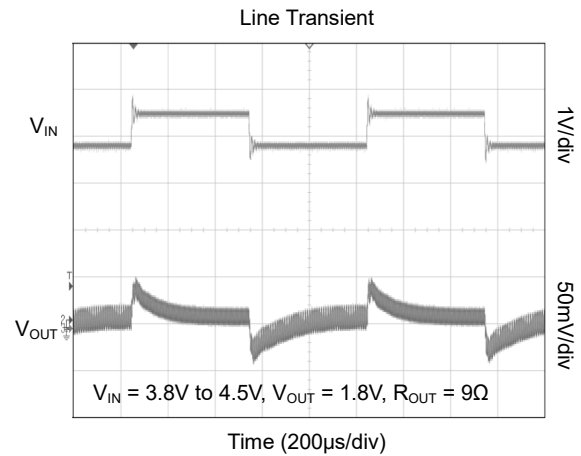
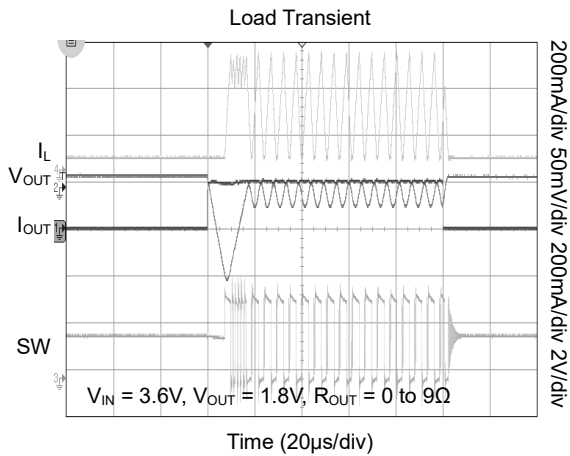
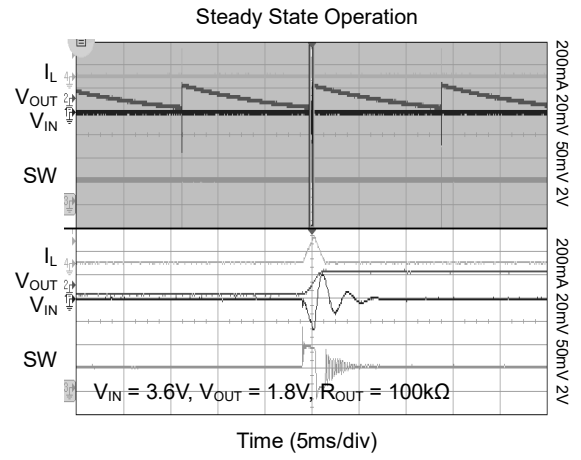
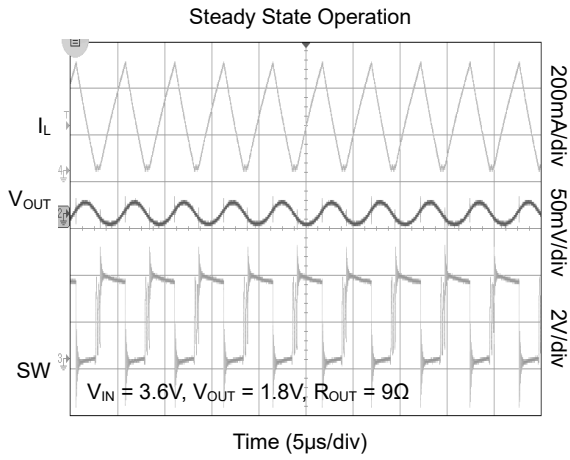

TYPICAL PERFORMANCE CHARACTERISTICS (continued)

T<sub>A</sub> = +25°C, unless otherwise noted.

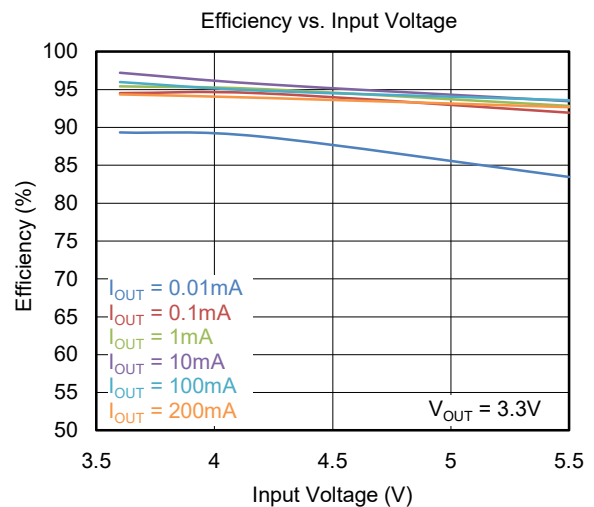
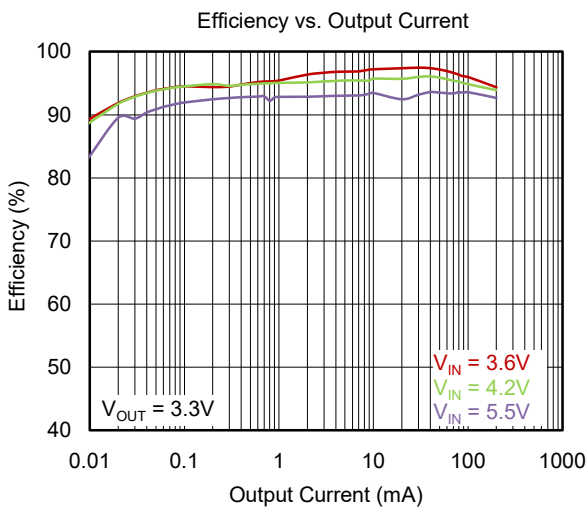
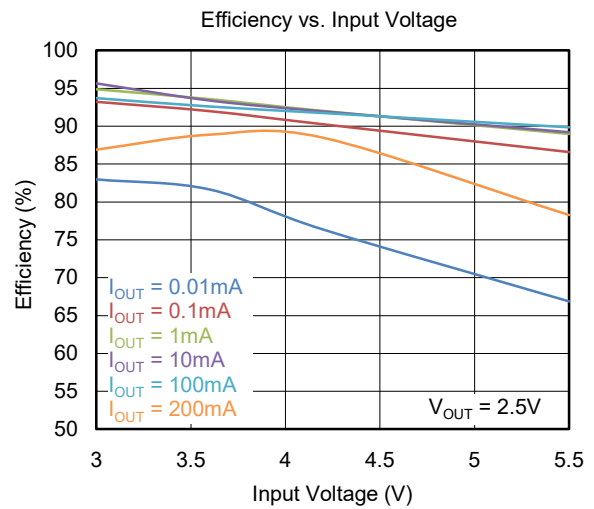
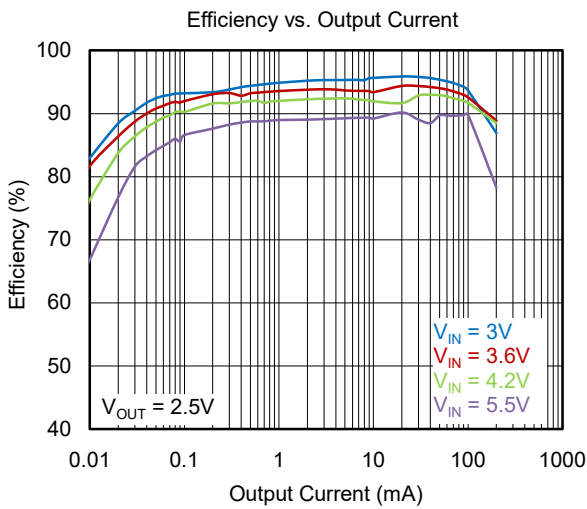
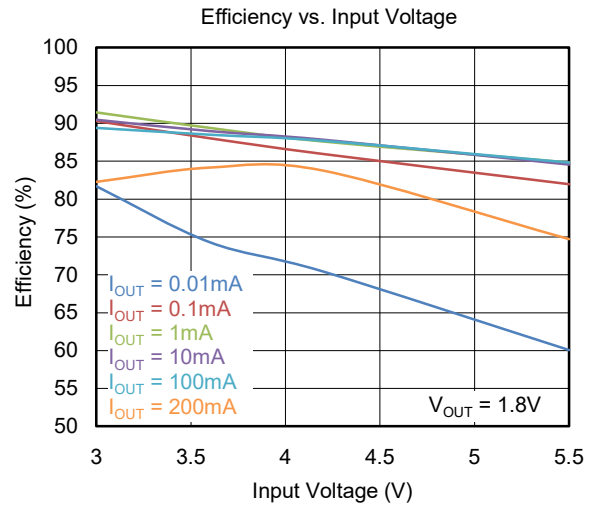
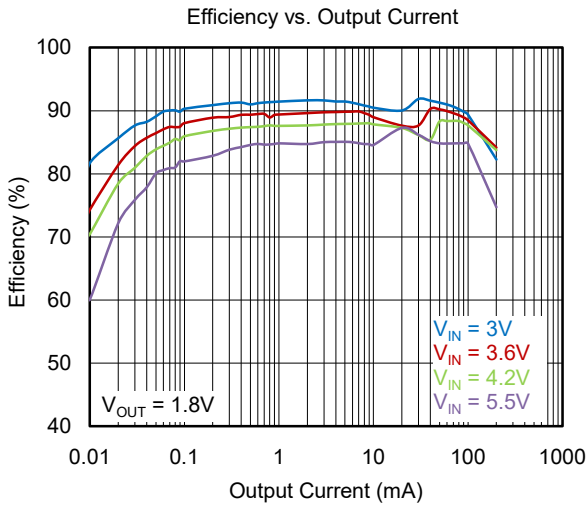

TYPICAL PERFORMANCE CHARACTERISTICS (continued)

T<sub>A</sub> = +25°C, unless otherwise noted.

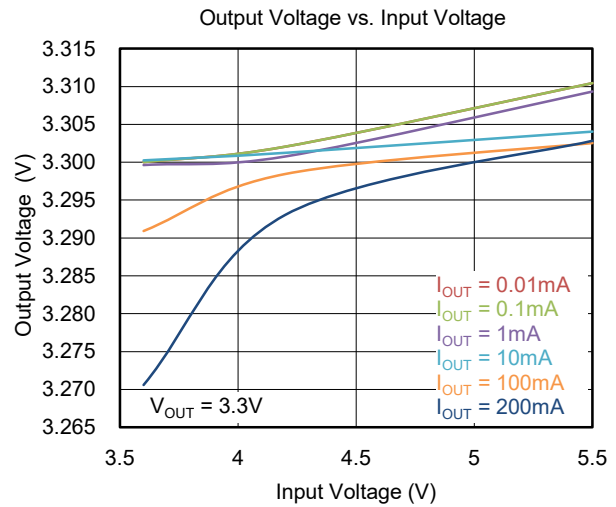
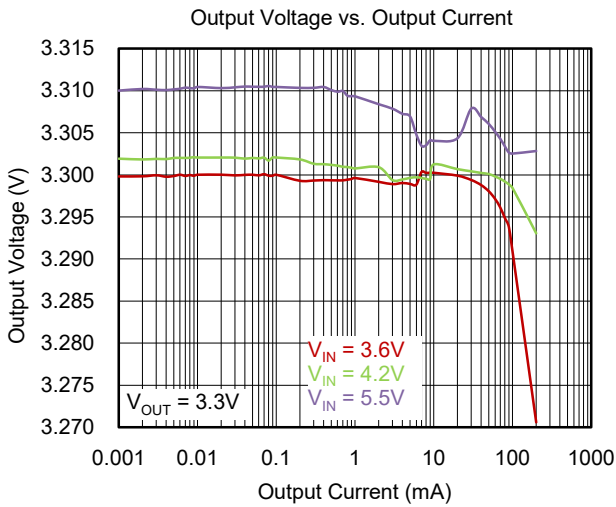
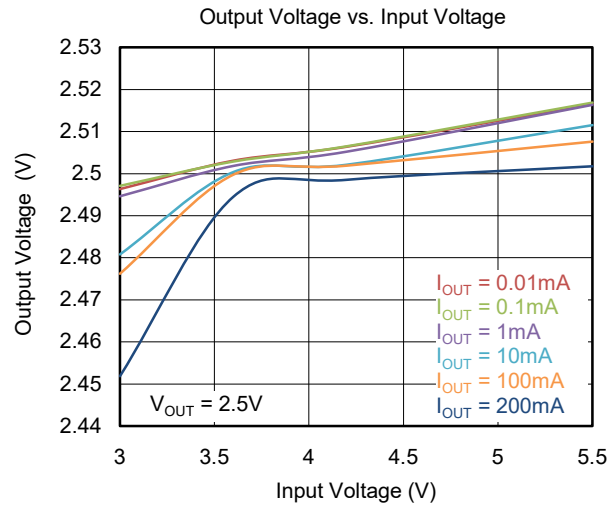
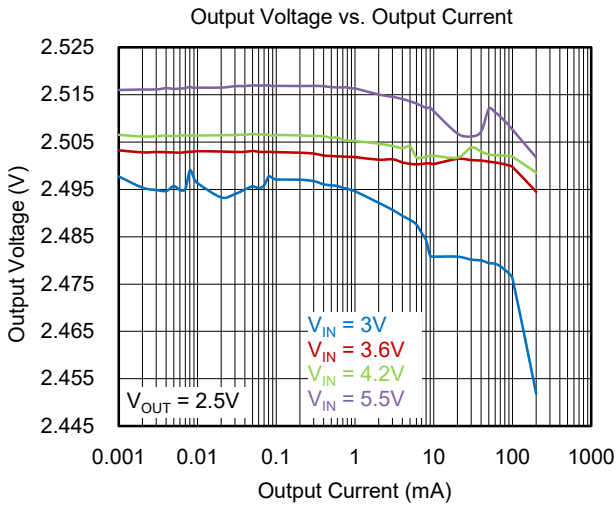
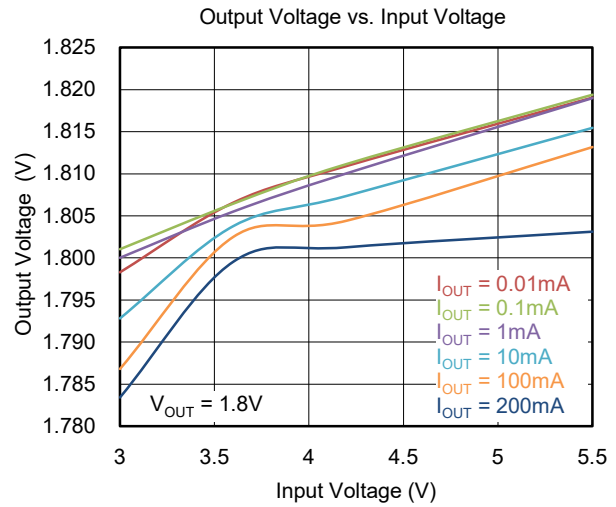
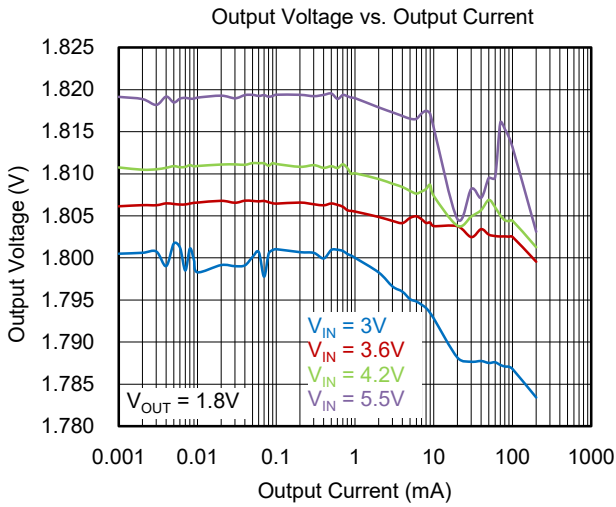

TYPICAL PERFORMANCE CHARACTERISTICS (continued)

T<sub>A</sub> = +25°C, unless otherwise noted.

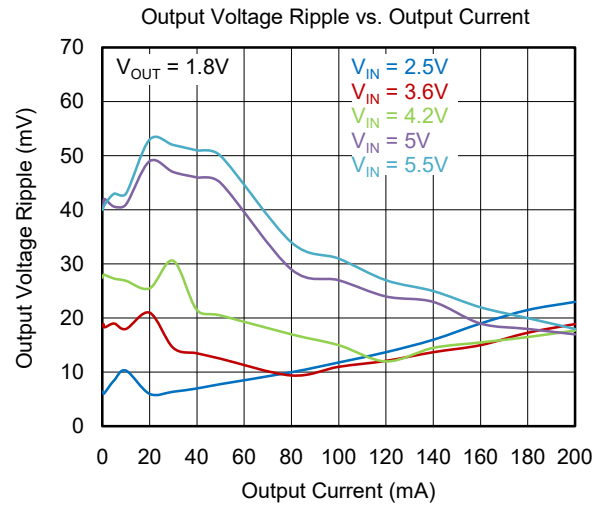
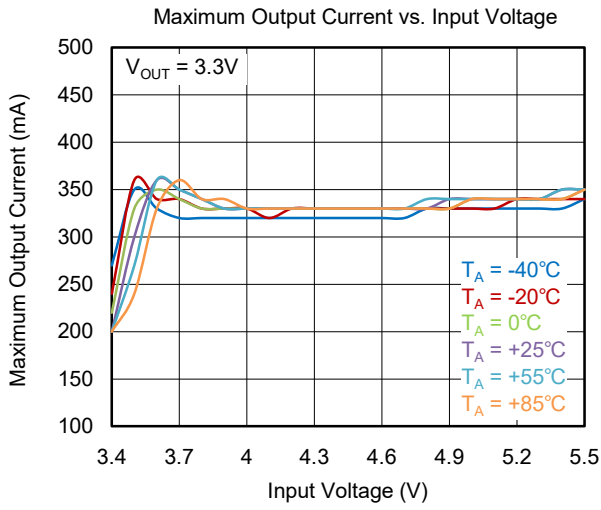



FUNCTIONAL BLOCK DIAGRAM

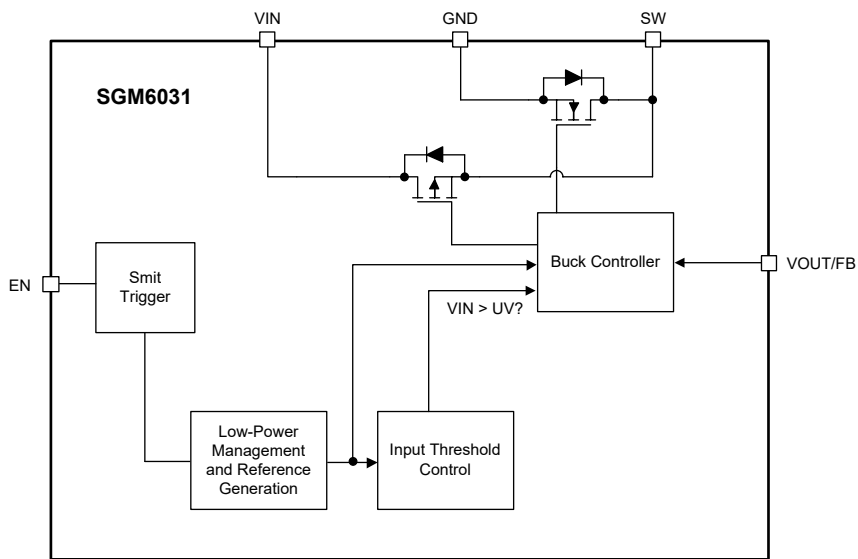

Figure 1. Block Diagram

TYPICAL APPLICATION CIRCUITS

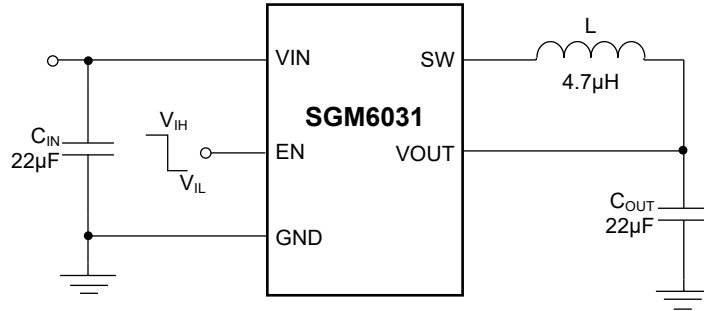

Figure 2. Fixed Voltage Typical Application Circuit

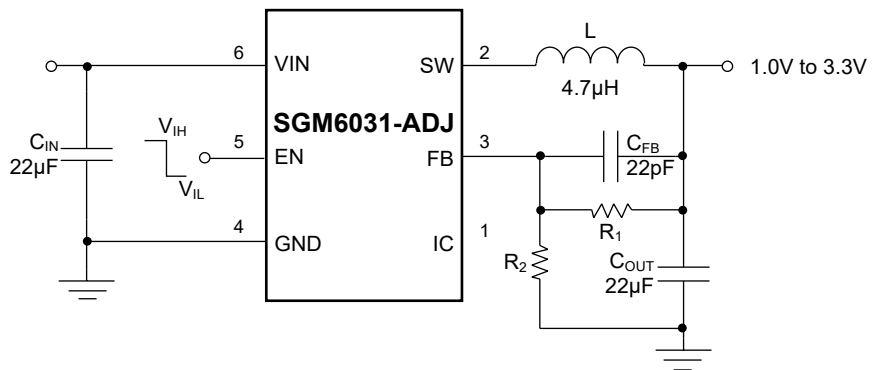

Figure 3. Adjustable Voltage Typical Application Circuit

## DETAILED DESCRIPTION

The SGM6031 family is a synchronous Buck converter with ultra-low quiescent current of 400nA (TYP). The device is improved to provide high efficiency ranging from 10 $\mu$ A to 200mA.

The SGM6031 implements the hysteretic control architecture to regulate the output voltage. The 400nA (TYP) quiescent current extends the operation lifetime for battery operated applications.

### Operation

The SGM6031 family is a Buck converter that is capable to regulate the voltage that is lower than the input voltage at the output. The device implements the pulse frequency modulation (PFM) control to regulate the voltage at light load. The SGM6031 delivers an average output current of 200mA with a peak inductor current of 430mA (TYP). The device implements an input under-voltage lockout (UVLO) function. When the input voltage drops below the UVLO threshold, the device stops operation. In addition to input UVLO function, the SGM6031 also implements the EN pin to allow external signal to control the turn-on and turn-off of the device. The device also implements output discharge function, when the EN pin is pulled to logic low, the low-side power FET remains on to discharge the output voltage. The SGM6031 also implements 100% duty cycle mode to bypass the input voltage to the

output when the input voltage is above the UVLO threshold.

### Under-Voltage Lockout (UVLO)

The device monitors the input voltage and shuts down itself when the input voltage is lower than UVLO threshold voltage. When the input voltage is higher than the UVLO threshold plus hysteresis, the device will start again.

### Thermal Shutdown (TSD)

A thermal shutdown function is implemented to prevent the damage caused by excessive heat and power dissipation. Once a temperature of +160°C (TYP) is exceeded, the device is shut down. The device is released from shutdown automatically when the junction temperature decreases by 20°C.

### Nano-Power Management and Efficiency

The SGM6031 implements the nano-power circuitry and algorithm to achieve 400nA (TYP) quiescent current. This feature is accomplished through sampling and all references are saved, so as to lower the average quiescent current. During the sampling and saving, the internal circuits are only turned on for a short period of time and then turned off in the remaining time at the lowest feasible duty cycle.

## APPLICATION INFORMATION

The SGM6031 family has ultra-low quiescent current and is capable of delivering up to 200mA load current, which is suitable for battery operated applications.

### Setting the Output Voltage

The output voltage is set by a resistor divider between the output voltage and the FB pin. The voltage divider divides the output voltage down to the feedback voltage by the ratio:

$$V_{FB} = V_{OUT} \frac{R_2}{R_1 + R_2} \quad (1)$$

where  $V_{FB}$  is the feedback voltage and  $V_{OUT}$  is the output voltage. Thus, the output voltage is:

$$V_{OUT} = 1.0 \times \frac{R_1 + R_2}{R_2} \quad (2)$$

The value for  $R_2$  can be as high as 1MΩ.

For example, for a 2V output voltage,  $R_2$  is 1MΩ, and  $R_1$  is 1MΩ.

### Design Procedure

A 4.7μH inductor and a 22μF input ceramic capacitor are recommended for the SGM6031. Since the device only supports 200mA output load, a 22μF output ceramic capacitor is sufficient. For applications that are expected to have a large transient event, use  $I_{TRAN} = C_{OUT} \times \Delta V_{OUT} / \Delta TIME$  to size the output capacitor accordingly, where  $\Delta V_{OUT}$  is the amount of output voltage drop during load step.

### Inductor Selection

The SGM6031 is optimized to work with a 4.7μH inductor. The selected inductor's saturation current should be at least 25% higher than the maximum cycle-by-cycle current limit specified in the Electrical Characteristics table. The SGM6031 is naturally stable due to its hysteretic control architecture.

The recommended inductors for SGM6031 are shown in Table 1.

**Table 1. Recommended Inductors**

Inductance (μH)	Dimensions (mm <sup>3</sup> )	Part Number	Manufacturer
4.7	2.0 × 2.5 × 1.2	DFE252012C-H-4R7M	Toko
4.7	4.0 × 4.0 × 1.7	LPS4018-472ML	Coilcraft

### Output Capacitor Selection

A minimal of 22μF ceramic output capacitor is recommended for SGM6031. Larger size will result in higher effective capacitance under the same DC de-rating, which improves the transient response and output ripple.

### Input Capacitor Selection

A 22μF ceramic capacitor and a 0.1μF ceramic bypass input capacitor are recommended to place between the VIN pin and GND as close as possible to minimize the parasitic inductance. For applications where the SGM6031 is located far away from the input source, a 22μF or higher capacitor is recommended to damp the inductance of the wiring harness.

**REVISION HISTORY**

NOTE: Page numbers for previous revisions may differ from page numbers in the current version.

	<b>Page</b>
<b>OCTOBER 2022 – REV.A.4 to REV.B</b>	
Updated the Detailed Description and Application Information sections .....	11, 12
<b>OCTOBER 2021 – REV.A.3 to REV.A.4</b>	
Updated the Electrical Characteristics section .....	4
<b>NOVEMBER 2017 – REV.A.2 to REV.A.3</b>	
Updated Figure 3.....	9
<b>OCTOBER 2017 – REV.A.1 to REV.A.2</b>	
Changed the marking information for SGM6031-3.0YUDT6G.....	2
<b>AUGUST 2017 – REV.A to REV.A.1</b>	
Changed SGM6031-3.0 STATUS from PREVIEW to ACTIVE .....	2
<b>Changes from Original (JUNE 2017) to REV.A</b>	
Changed from product preview to production data.....	All

PACKAGE OUTLINE DIMENSIONS

UTDFN-1.5x2-6L

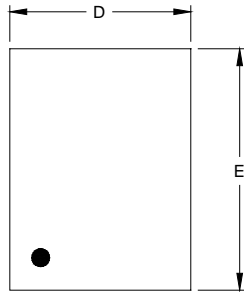

TOP VIEW

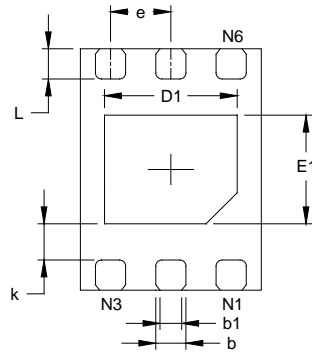

BOTTOM VIEW

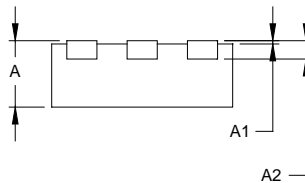

SIDE VIEW

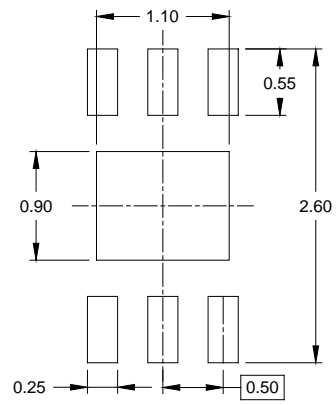

RECOMMENDED LAND PATTERN (Unit: mm)

Symbol	Dimensions In Millimeters		Dimensions In Inches	
	MIN	MAX	MIN	MAX
A	0.500	0.600	0.020	0.024
A1	0.000	0.050	0.000	0.002
A2	0.152 REF		0.006 REF	
D	1.400	1.600	0.055	0.063
D1	1.000	1.200	0.039	0.047
E	1.900	2.100	0.075	0.083
E1	0.800	1.000	0.031	0.039
k	0.300 REF		0.012 REF	
b	0.200	0.300	0.008	0.012
b1	0.180 REF		0.007 REF	
e	0.500 BSC		0.020 BSC	
L	0.200	0.300	0.008	0.012

NOTE: This drawing is subject to change without notice.

# PACKAGE INFORMATION

## TAPE AND REEL INFORMATION

### REEL DIMENSIONS



### TAPE DIMENSIONS



NOTE: The picture is only for reference. Please make the object as the standard.

### KEY PARAMETER LIST OF TAPE AND REEL

Package Type	Reel Diameter	Reel Width W1 (mm)	A0 (mm)	B0 (mm)	K0 (mm)	P0 (mm)	P1 (mm)	P2 (mm)	W (mm)	Pin1 Quadrant
UTDFN-1.5×2-6L	7"	9.5	1.70	2.30	0.75	4.0	4.0	2.0	8.0	Q2

000001

# PACKAGE INFORMATION

## CARTON BOX DIMENSIONS



NOTE: The picture is only for reference. Please make the object as the standard.

## KEY PARAMETER LIST OF CARTON BOX

Reel Type	Length (mm)	Width (mm)	Height (mm)	Pizza/Carton
7" (Option)	368	227	224	8
7"	442	410	224	18

DD0002