

### GENERAL DESCRIPTION

The SGM6232 is a current-mode buck converter with an internal power MOSFET switch. This device has a fixed switching frequency of 1.4MHz and an adjustable output voltage range of 0.8V to 28V. It can efficiently provide up to 2A output load current over a wide input supply range from 4.5V to 38V with excellent load and line regulations responses.

The SGM6232 is highly efficient with peak efficiency at 91% when in operation. The shutdown supply current consumed by the regulator is less than 18µA. Protection features include cycle-by-cycle current limit and thermal shutdown. The device also includes an internal soft-start and an external adjustable soft-start function to limit the inrush current and prevent the overshoot of output voltage.

The SGM6232 is available in a Green SOIC-8 (Exposed Pad) package and also minimizes the external components of the device to complete a 2A buck DC/DC converter solution.

### FEATURES

- 4.5V to 38V Input Voltage Range
- 0.8V to 28V Adjustable Output Voltage Range
- 2A Output Current
- 91% Peak Efficiency
- Shutdown Supply Current: 18µA (MAX)
- 100mΩ Internal Power MOSFET Switch
- 1.4MHz Fixed Switching Frequency
- Under-Voltage Lockout
- Cycle-by-Cycle Current Limit Protection
- Thermal Shutdown Protection
- Support Low ESR Ceramic Capacitors
- -40°C to +85°C Operating Temperature Range
- Available in Green SOIC-8 (Exposed Pad) Package

### APPLICATIONS

- Battery Chargers
- Flat Panel TVs
- Set-Top Boxes
- Cigarette Lighter Powered Devices
- Pre-Regulators

### TYPICAL APPLICATION

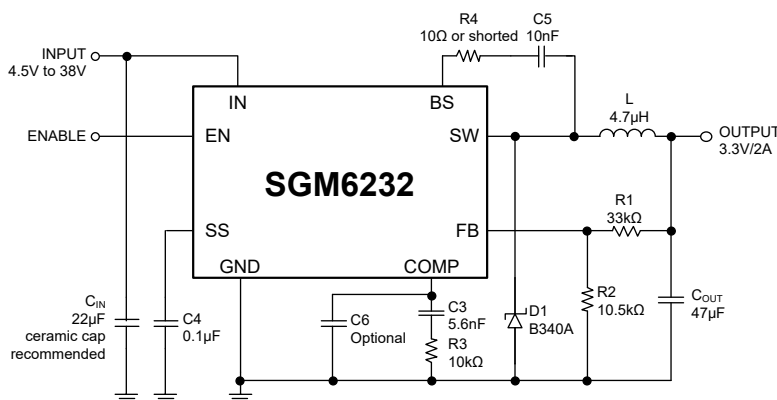
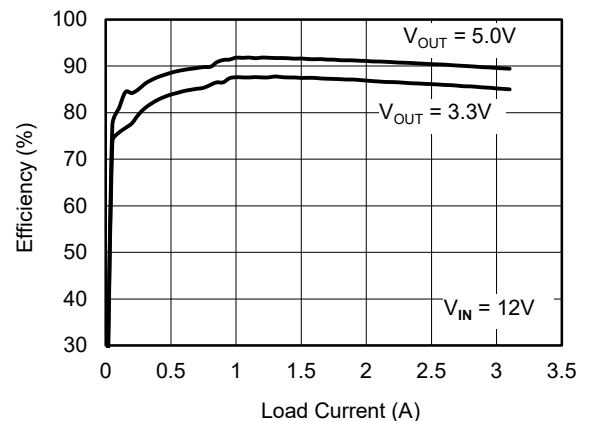

Figure 1. Typical Application Circuit



**PACKAGE/ORDERING INFORMATION**

MODEL	PACKAGE DESCRIPTION	SPECIFIED TEMPERATURE RANGE	ORDERING NUMBER	PACKAGE MARKING	PACKING OPTION
SGM6232	SOIC-8 (Exposed Pad)	-40°C to +85°C	SGM6232YPS8G/TR	SGM 6232YPS8 XXXXX	Tape and Reel, 2500

**MARKING INFORMATION**

NOTE: XXXXXX = Date Code and Vendor Code.

**XXXXX**

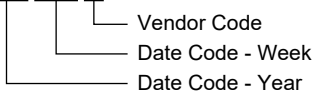

Green (RoHS & HSF): SG Micro Corp defines "Green" to mean Pb-Free (RoHS compatible) and free of halogen substances. If you have additional comments or questions, please contact your SGMICRO representative directly.

**ABSOLUTE MAXIMUM RATINGS**

- Supply Voltage,  $V_{IN}$ ..... -0.3V to 40V
- SW Voltage,  $V_{SW}$ .....-0.5V to  $V_{IN} + 0.3V$
- Boost Voltage,  $V_{BS}$ .....  $V_{SW} - 0.3V$  to  $V_{SW} + 6V$
- All Other Pins..... -0.3V to 6V
- Package Thermal Resistance
- SOIC-8 (Exposed Pad),  $\theta_{JA}$  ..... 50°C/W
- Operating Temperature Range ..... -40°C to +85°C
- Junction Temperature.....+150°C
- Storage Temperature Range .....-65°C to +150°C
- Lead Temperature (Soldering, 10s).....+260°C
- ESD Susceptibility
- HBM.....4000V
- MM.....200V

**OVERSTRESS CAUTION**

Stresses beyond those listed in Absolute Maximum Ratings may cause permanent damage to the device. Exposure to absolute maximum rating conditions for extended periods may affect reliability. Functional operation of the device at any conditions beyond those indicated in the Recommended Operating Conditions section is not implied.

**ESD SENSITIVITY CAUTION**

This integrated circuit can be damaged by ESD if you don't pay attention to ESD protection. SGMICRO recommends that all integrated circuits be handled with appropriate precautions. Failure to observe proper handling and installation procedures can cause damage. ESD damage can range from subtle performance degradation to complete device failure. Precision integrated circuits may be more susceptible to damage because very small parametric changes could cause the device not to meet its published specifications.

**DISCLAIMER**

SG Micro Corp reserves the right to make any change in circuit design, or specifications without prior notice.

## PIN CONFIGURATION

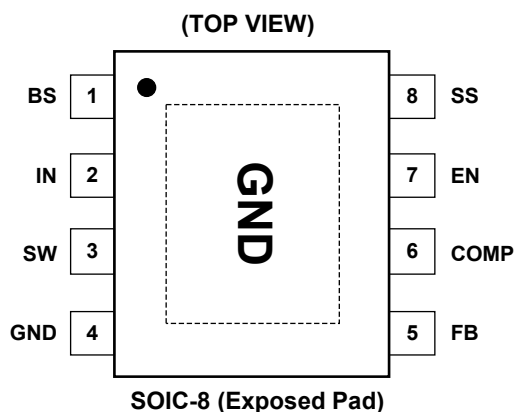

## PIN DESCRIPTION

PIN	NAME	FUNCTION
1	BS	High-side Gate Drive Boost Input. A 10 $\Omega$ resistor placed between SW and BS cap is strongly recommended to reduce SW spike voltage.
2	IN	Power Input. This pin powers the device and step-down converter switches. A large enough capacitor is used to bypass this pin to GND to eliminate input's noise.
3	SW	Power Switching Output. Place a capacitor between SW and BS to supply the high-side switch.
4	GND	Ground. (Exposed pad is connected to the backside of GND)
5	FB	Feedback Input. Connect to the resistor divider between output and ground to set output voltage.
6	COMP	Compensation Node for regulation control loop compensation. An additional capacitor between COMP and GND may be needed.
7	EN	Enable Input for regulator's turn-on or turn-off. Drive EN high to turn on the regulator, and drive EN low to turn it off. Output voltage is discharged when the IC is off. EN is disconnected in automatic startup.
8	SS	Soft-Start Control Input. A capacitor is placed between SS and GND to set the soft-start period. Disconnect the SS to disable the soft-start function.
Exposed Pad	GND	Power Ground Exposed Pad. Must be connected to GND plane.

**ELECTRICAL CHARACTERISTICS**(V<sub>IN</sub> = 12V, T<sub>A</sub> = +25°C, unless otherwise noted.)

PARAMETER	SYMBOL	CONDITIONS	MIN	TYP	MAX	UNITS
Input Voltage Range	V <sub>IN</sub>		4.5		38	V
Feedback Voltage	V <sub>FB</sub>		0.776	0.8	0.824	V
Shutdown Supply Current	I <sub>SHDN</sub>	V <sub>EN</sub> = 0V		10	18	μA
Quiescent Supply Current	I <sub>Q</sub>	V <sub>EN</sub> = 2.6V, V <sub>FB</sub> = 1V		0.8	1.7	mA
High-side Switch (M1) On-Resistance	R <sub>ONH</sub>			100		mΩ
Low-side Switch (M2) On-Resistance	R <sub>ONL</sub>			10		Ω
Error Amplifier Transconductance	G <sub>EA</sub>	ΔV <sub>FB</sub> = ±12.5mV	500	800	1120	μA/V
Error Amplifier Voltage Gain	A <sub>EA</sub>			10000		V/V
SW Leakage Current	I <sub>LSW</sub>	V <sub>EN</sub> = 0V, V <sub>SW</sub> = 0V			1	μA
Current Limit	I <sub>LIM</sub>			4.2		A
Current Sense to COMP Transconductance	G <sub>CS</sub>			6.2		A/V
Maximum Duty Cycle	D <sub>MAX</sub>	V <sub>FB</sub> = 0.6V		80		%
Minimum Duty Cycle	D <sub>MIN</sub>	V <sub>FB</sub> = 1V		0		%
EN Threshold Voltage	V <sub>IH</sub>		1.2			V
EN Threshold Voltage	V <sub>IL</sub>				0.4	V
EN Pull-Up Current		V <sub>EN</sub> = 0V	0.8	1.4	2	μA
Oscillator Frequency	f <sub>OSC</sub>		1.15	1.4	1.6	MHz
Short Circuit Oscillator Frequency		V <sub>FB</sub> = 0V		140		kHz
Under-Voltage Lockout Threshold		V <sub>IN</sub> Rising	3.5	3.8	4.2	V
Under-Voltage Lockout Threshold Hysteresis				230		mV
Soft-Start Period		C <sub>SS</sub> = 0.1μF		10		ms
Thermal Shutdown Temperature	T <sub>SHDN</sub>			160		°C

TYPICAL PERFORMANCE CHARACTERISTICS

$V_{IN} = 12V$ ,  $C_{IN} = 22\mu F$ ,  $C_{OUT} = 47\mu F$  and  $T_A = +25^\circ C$ , unless otherwise noted.

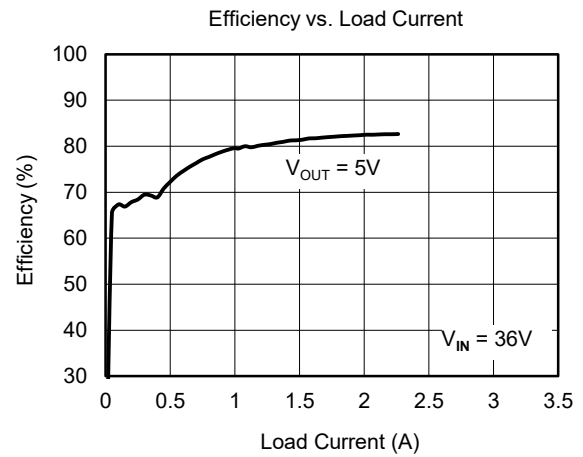
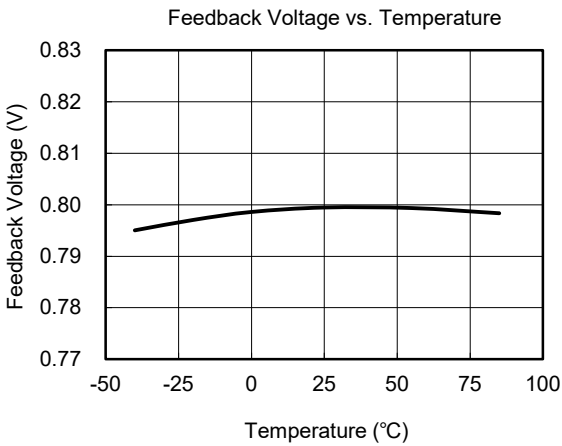
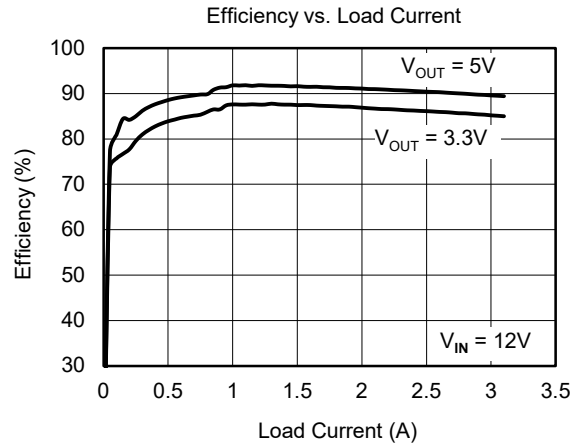
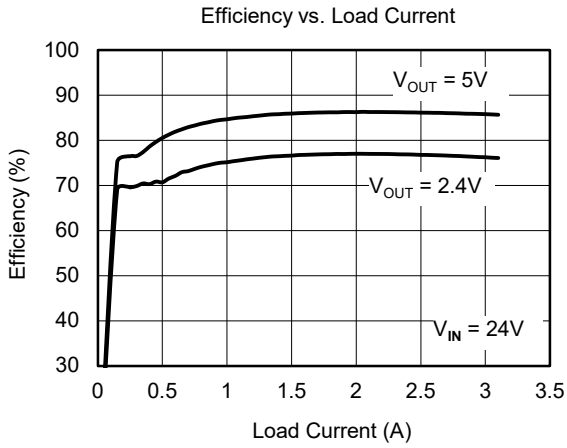

TYPICAL PERFORMANCE CHARACTERISTICS (continued)

V<sub>IN</sub> = 12V, C<sub>IN</sub> = 22μF, C<sub>OUT</sub> = 47μF and T<sub>A</sub> = +25°C, unless otherwise noted.

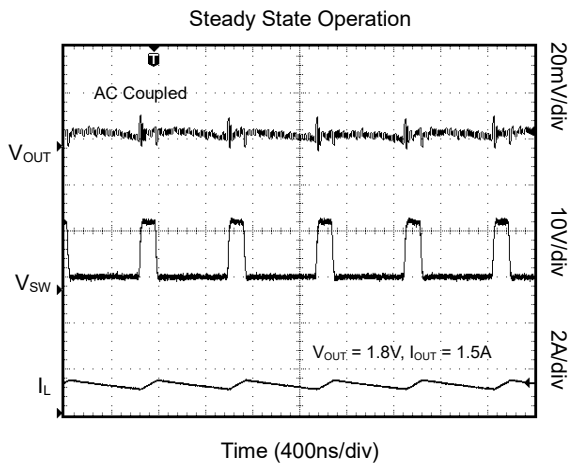
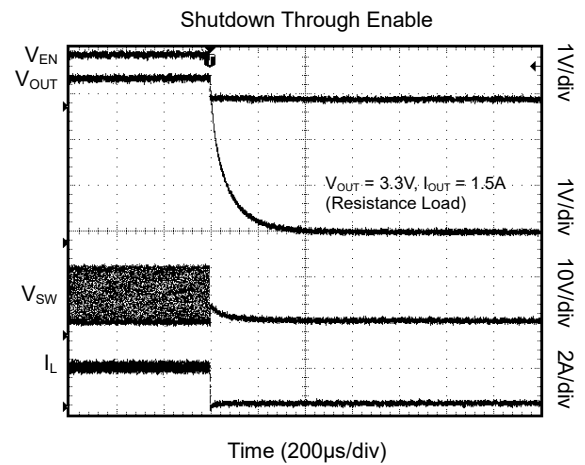
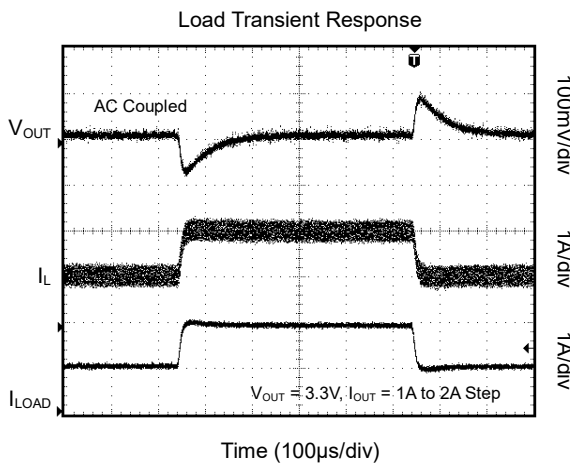
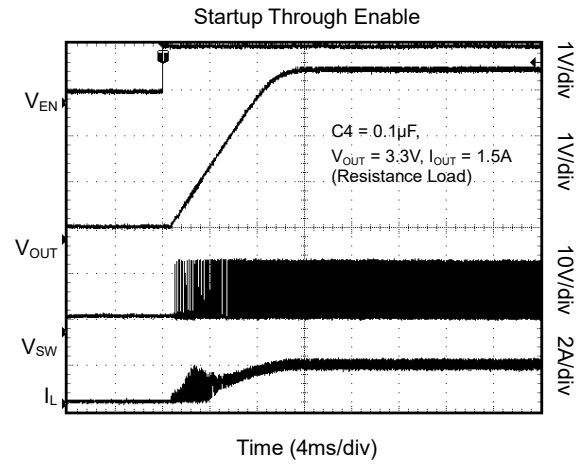
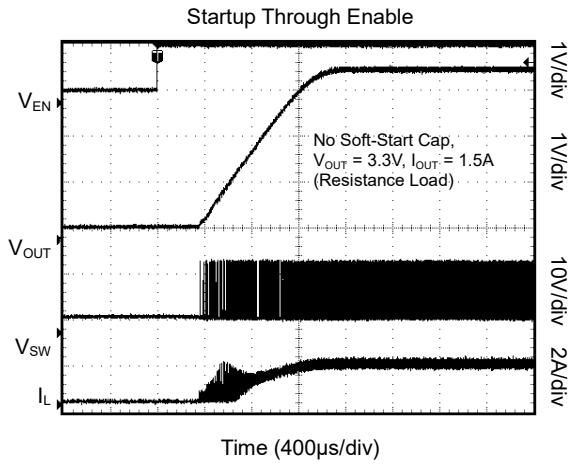

**REVISION HISTORY**

NOTE: Page numbers for previous revisions may differ from page numbers in the current version.

**JULY 2015 – REV.A.1 to REV.A.2**

---

Change Typical Application and input capacitor..... 1, 8

---

**JULY 2014 – REV.A to REV.A.1**

---

Add a 10Ω resistor between SW and BS pin in Typical Application..... 1, 3, 10

---

**Changes from Original (APRIL 2010) to REV.A**

---

Changed from product preview to production data..... All

---

PACKAGE OUTLINE DIMENSIONS

SOIC-8 (Exposed Pad)

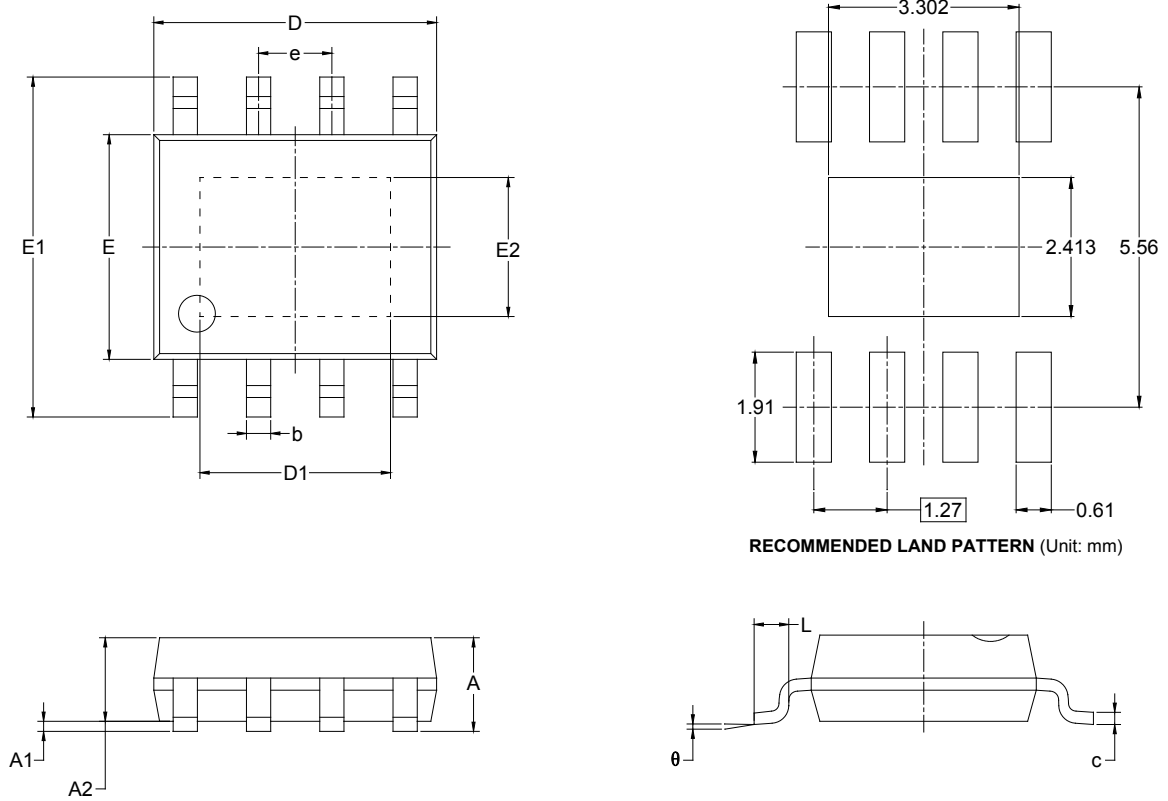

RECOMMENDED LAND PATTERN (Unit: mm)

Symbol	Dimensions In Millimeters		Dimensions In Inches	
	MIN	MAX	MIN	MAX
A		1.700		0.067
A1	0.000	0.100	0.000	0.004
A2	1.350	1.550	0.053	0.061
b	0.330	0.510	0.013	0.020
c	0.170	0.250	0.007	0.010
D	4.700	5.100	0.185	0.201
D1	3.202	3.402	0.126	0.134
E	3.800	4.000	0.150	0.157
E1	5.800	6.200	0.228	0.244
E2	2.313	2.513	0.091	0.099
e	1.27 BSC		0.050 BSC	
L	0.400	1.270	0.016	0.050
θ	0°	8°	0°	8°



# PACKAGE INFORMATION

## TAPE AND REEL INFORMATION

### REEL DIMENSIONS



### TAPE DIMENSIONS



NOTE: The picture is only for reference. Please make the object as the standard.

### KEY PARAMETER LIST OF TAPE AND REEL

Package Type	Reel Diameter	Reel Width W1 (mm)	A0 (mm)	B0 (mm)	K0 (mm)	P0 (mm)	P1 (mm)	P2 (mm)	W (mm)	Pin1 Quadrant
SOIC-8 (Exposed Pad)	13"	12.4	6.40	5.40	2.10	4.0	8.0	2.0	12.0	Q1

000001

# PACKAGE INFORMATION

## CARTON BOX DIMENSIONS



NOTE: The picture is only for reference. Please make the object as the standard.

## KEY PARAMETER LIST OF CARTON BOX

Reel Type	Length (mm)	Width (mm)	Height (mm)	Pizza/Carton
13"	386	280	370	5

DD0002