

GENERAL DESCRIPTION

The SGM66055A is an internally compensated, 2.2MHz switching frequency, peak current mode, synchronous Boost switching converter. Even below the minimum system battery voltage, the device maintains the output voltage regulation for a minimum output load current of 0.7A. This device turns into power-save mode to maintain high efficiency by lowering switching frequency. With its anti-ringing circuitry damping the charge in parasitic capacitor, it reduces EMI interference significantly.

In addition, the SGM66055A device can also support the pass-through mode by pulling EN to low. In this mode, the output voltage follows the input voltage with a voltage drop by the resistance of the inductor and high-side MOSFET.

The SGM66055A-5.0 and SGM66055A-5.4 are preset for outputting 5.0V and 5.4V respectively.

The device is available in a Green WLCSP-1.21×1.21-9B package and operates over an ambient temperature range of -40°C to +85°C.

FEATURES

- **Operating Input Voltage Range: 2.5V to 4.5V**
- **Fixed Output Voltages: 5.0V and 5.4V**
- **Output Voltage Clamping: 5.7V**
- **Up to 93% Efficiency**
- **Quiescent Current: 23µA (TYP)**
- **Improved Light Load Efficiency with Power-Save Mode (PSM)**
- **Pass-through Mode by Pulling EN Low**
- **Low Reverse Leakage Current when $V_{OUT} > V_{IN}$**
- **Thermal Shutdown**
- **Available in a Green WLCSP-1.21×1.21-9B Package**
- **-40°C to +85°C Operating Temperature Range**

APPLICATIONS

- USB OTG
- Class-D Audio Amplifier
- Smart Phones and Tablets
- Portable and Wearable Devices

TYPICAL APPLICATION

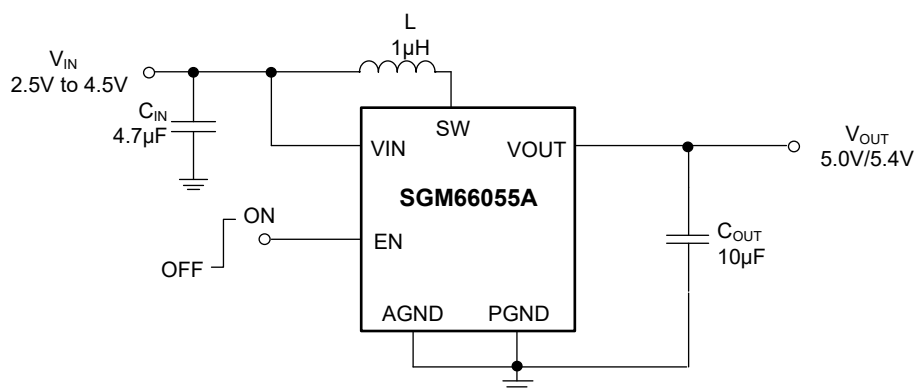

Figure 1. Typical Application Circuit

PACKAGE/ORDERING INFORMATION

MODEL	V _{OUT} (V)	PACKAGE DESCRIPTION	SPECIFIED TEMPERATURE RANGE	ORDERING NUMBER	PACKAGE MARKING	PACKING OPTION
SGM66055A	5.0	WLCSP-1.21×1.21-9B	-40°C to +85°C	SGM66055A-5.0YG/TR	GP2 XXXX	Tape and Reel, 3000
	5.4	WLCSP-1.21×1.21-9B	-40°C to +85°C	SGM66055A-5.4YG/TR	GP3 XXXX	Tape and Reel, 3000

MARKING INFORMATION

NOTE: XXXX = Date Code.

YYY — Serial Number

XXXX

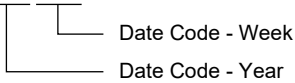

Green (RoHS & HSF): SG Micro Corp defines "Green" to mean Pb-Free (RoHS compatible) and free of halogen substances. If you have additional comments or questions, please contact your SGMICRO representative directly.

ABSOLUTE MAXIMUM RATINGS

- Voltage on VIN Pin -0.3V to 5.5V
- Voltage on VOUT Pin 6V
- SW Node (DC)..... -0.3V to 6V
- SW Node (Transient: 10ns, 3MHz) -1V to 8V
- Voltage on Other Pins..... -0.3V to 6V⁽¹⁾
- Package Thermal Resistance
- WLCSP-1.21×1.21-9B, θ_{JA}.90°C/W
- Junction Temperature.....+150°C
- Storage Temperature Range -65°C to +150°C
- Lead Temperature (Soldering, 10s).....+260°C
- ESD Susceptibility
- HBM..... 4000V
- MM..... 400V
- CDM 1000V

NOTE: 1. Lesser of 6V or V_{IN} + 0.3V.

OVERSTRESS CAUTION

Stresses beyond those listed in Absolute Maximum Ratings may cause permanent damage to the device. Exposure to absolute maximum rating conditions for extended periods may affect reliability. Functional operation of the device at any conditions beyond those indicated in the Recommended Operating Conditions section is not implied.

ESD SENSITIVITY CAUTION

This integrated circuit can be damaged by ESD if you don't pay attention to ESD protection. SGMICRO recommends that all integrated circuits be handled with appropriate precautions. Failure to observe proper handling and installation procedures can cause damage. ESD damage can range from subtle performance degradation to complete device failure. Precision integrated circuits may be more susceptible to damage because very small parametric changes could cause the device not to meet its published specifications.

DISCLAIMER

SG Micro Corp reserves the right to make any change in circuit design, or specifications without prior notice.

PIN CONFIGURATION

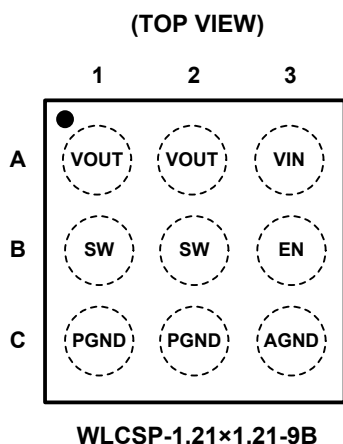

PIN DESCRIPTION

PIN	NAME	FUNCTION
A1, A2	VOUT	Boost Converter Output.
A3	VIN	Power Supply Input.
B1, B2	SW	Switching Node. SW connects to an inductor.
B3	EN	Device Enable Node. Pulling this pin logic high enables the device and pulling it logic low disables the device.
C1, C2	PGND	Power Ground.
C3	AGND	Analog Ground.

ELECTRICAL CHARACTERISTICS(V_{IN} = 3.6V, Full = -40°C to +85°C, typical values are at T_A = +25°C, unless otherwise noted.)

PARAMETER	SYMBOL	CONDITIONS	TEMP	MIN	TYP	MAX	UNITS
DC/DC STAGE							
Input Voltage Range	V _{IN}		+25°C	2.5		4.5	V
Switching Frequency	f _{SW}		Full	1.80	2.20	2.55	MHz
Switch Current Limit	I _L	SGM66055A-5.0	+25°C	2.2	3.0	3.5	A
		SGM66055A-5.4	+25°C	0.9	1.3	1.7	
Boost Switch On-Resistance		V _{OUT} = 5.0V	+25°C		50	65	mΩ
Rectifying Switch On-Resistance		V _{OUT} = 5.0V	+25°C		60	80	mΩ
Output Voltage		SGM66055A-5.0	Full	4.89	5.00	5.15	V
		SGM66055A-5.4	Full	5.25	5.40	5.48	
Line Regulation		V _{IN} = 2.5V to V _{OUT} - 0.5V	+25°C		0.1		%
Load Regulation			+25°C		0.2		%
Quiescent Current	I _Q	V _{EN} = V _{IN} = 3.6V, not switching	+25°C		23	33	μA
Shutdown Current	I _{SD}	V _{EN} = 0V, V _{IN} = 3.6V	+25°C			2.5	μA
CONTROL STAGE							
EN Input Low Voltage	V _{IL}		Full			0.4	V
EN Input High Voltage	V _{IH}		Full	1.3			V
EN Input Current	I _{EN}	Clamped on GND or VIN	Full	-1		1	μA
Over-Temperature Protection	T _{SD}				150		°C
Over-Temperature Hysteresis	T _{SD_HYS}				20		°C

TYPICAL PERFORMANCE CHARACTERISTICS

T_A = +25°C, V_{IN} = 3.6V, C_{IN} = 4.7µF, C_{OUT} = 20µF, unless otherwise noted.

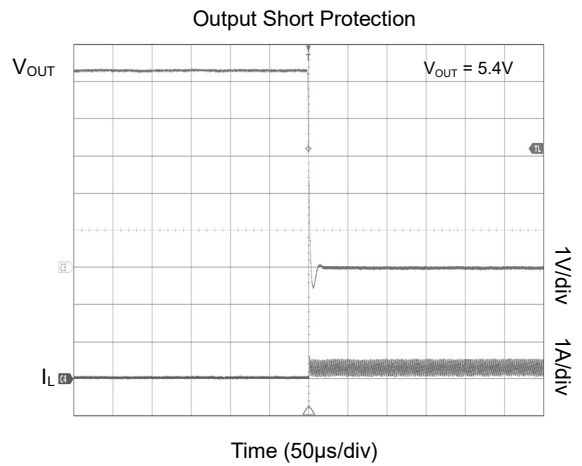
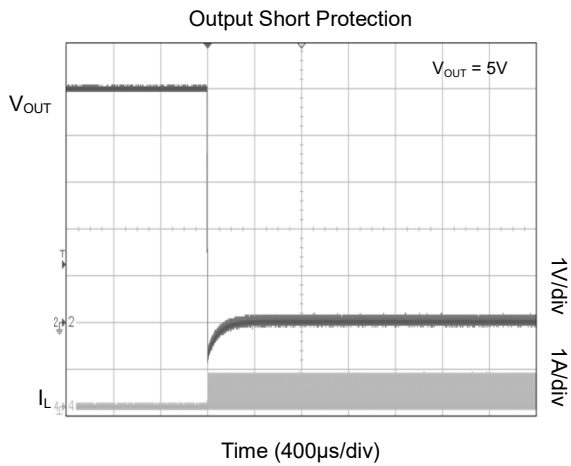
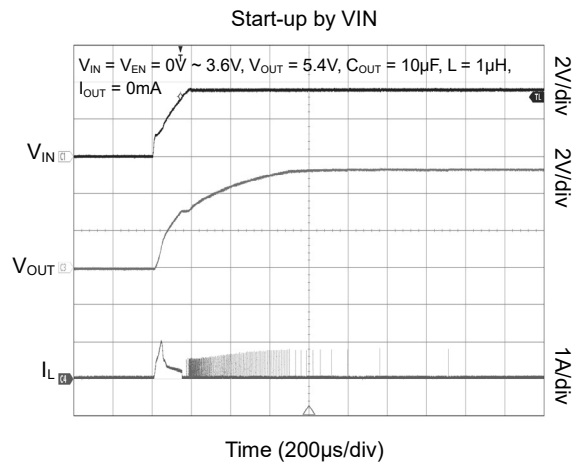
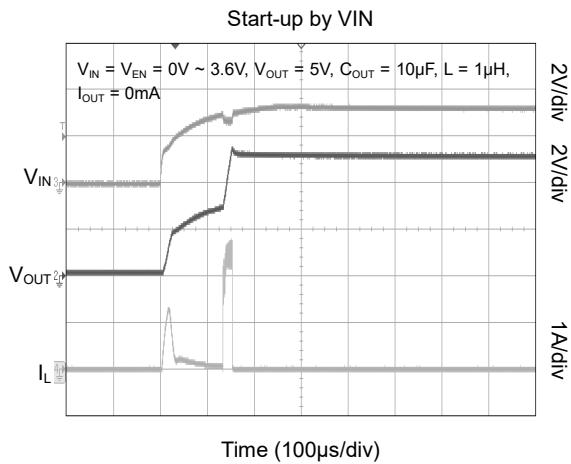
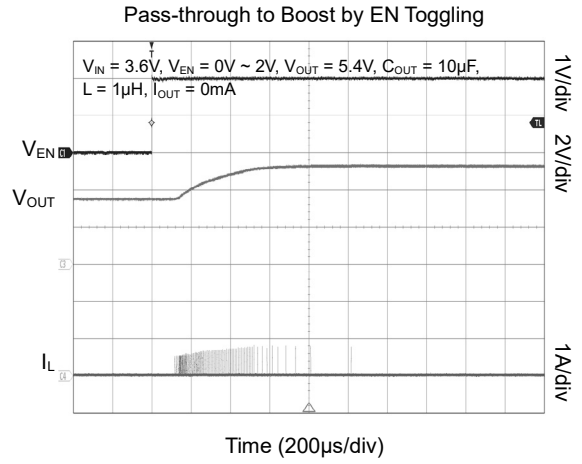
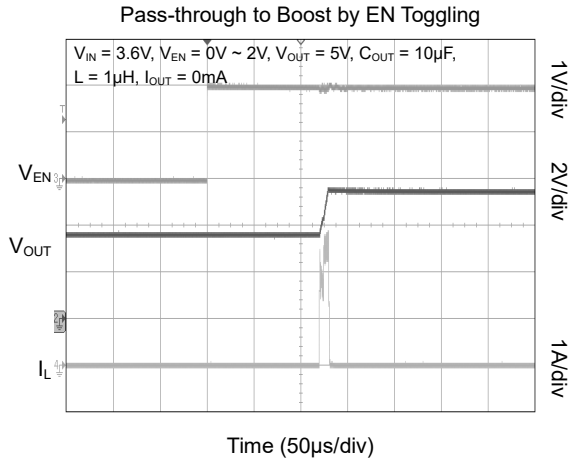

TYPICAL PERFORMANCE CHARACTERISTICS (continued)

T_A = +25°C, V_{IN} = 3.6V, C_{IN} = 4.7µF, C_{OUT} = 20µF, unless otherwise noted.

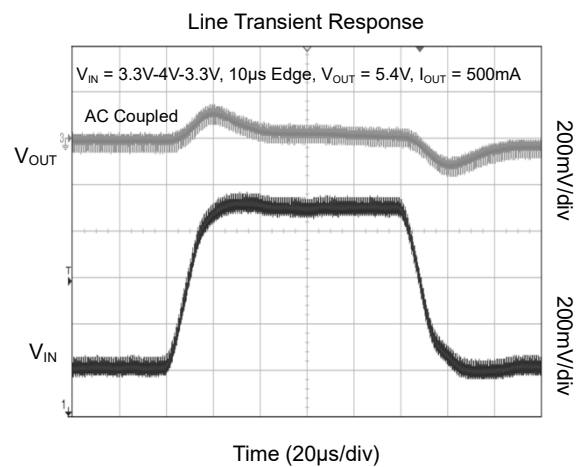
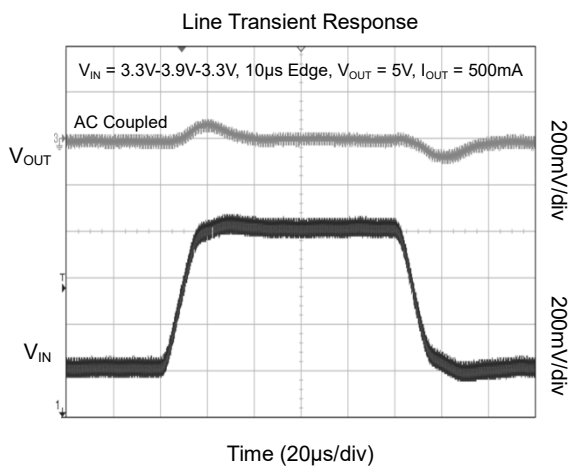
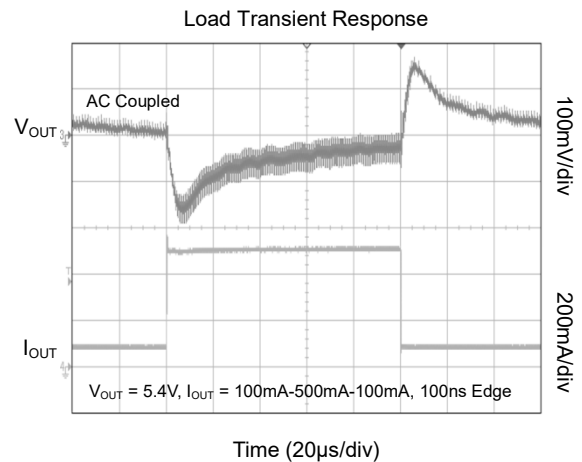
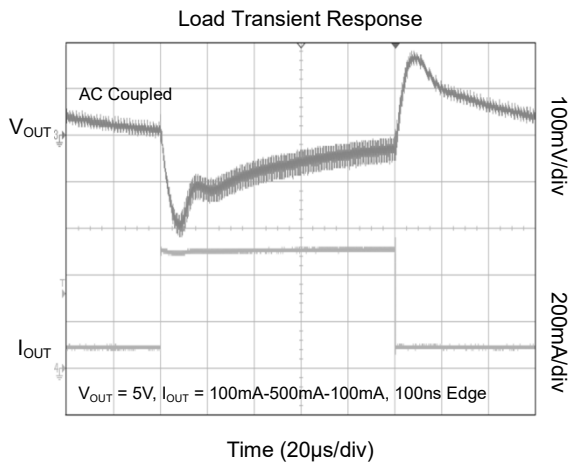
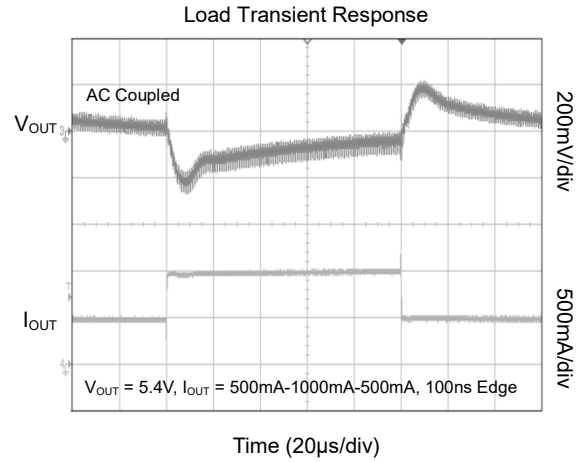
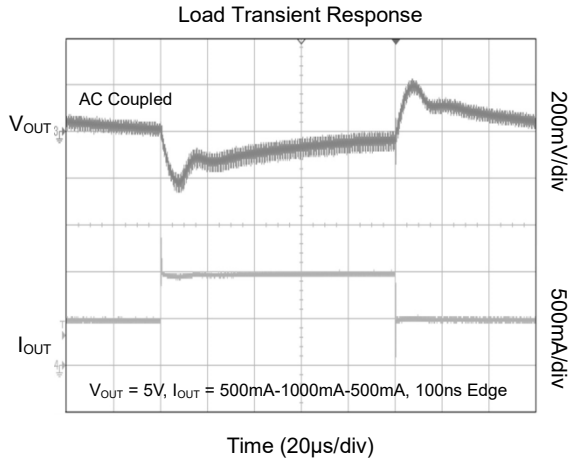

TYPICAL PERFORMANCE CHARACTERISTICS (continued)

$T_A = +25^\circ\text{C}$, $V_{IN} = 3.6\text{V}$, $C_{IN} = 4.7\mu\text{F}$, $C_{OUT} = 20\mu\text{F}$, unless otherwise noted.

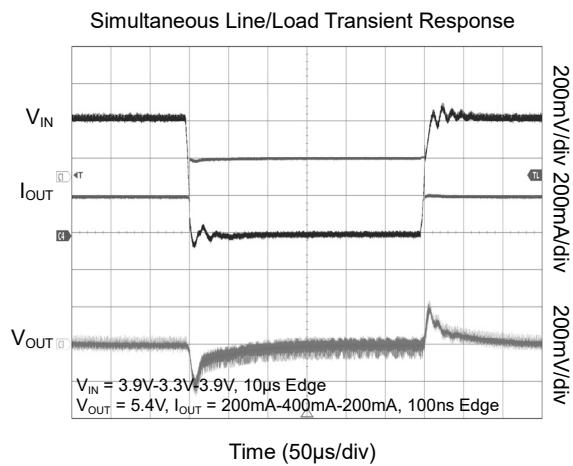
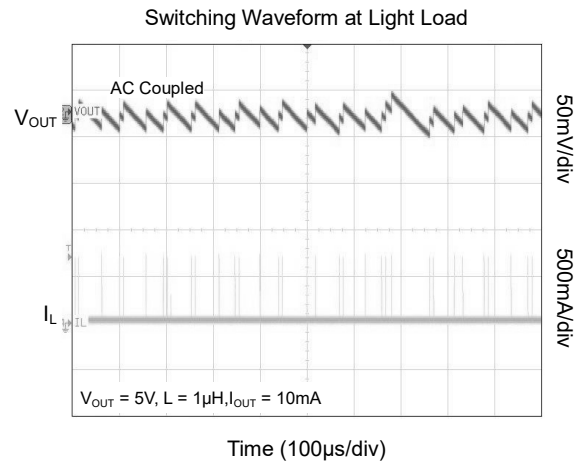
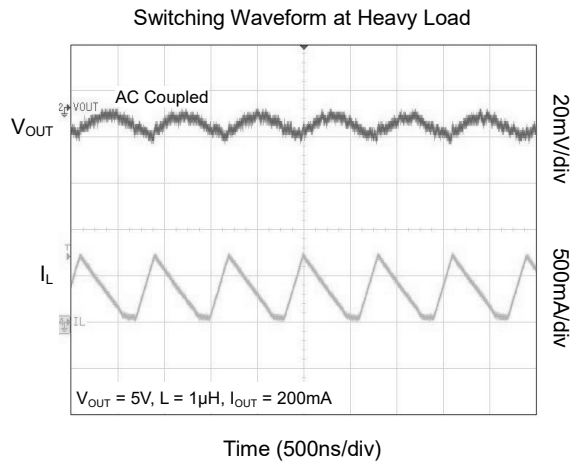

TYPICAL PERFORMANCE CHARACTERISTICS (continued)

T_A = +25°C, V_{IN} = 3.6V, C_{IN} = 4.7µF, C_{OUT} = 20µF, unless otherwise noted.

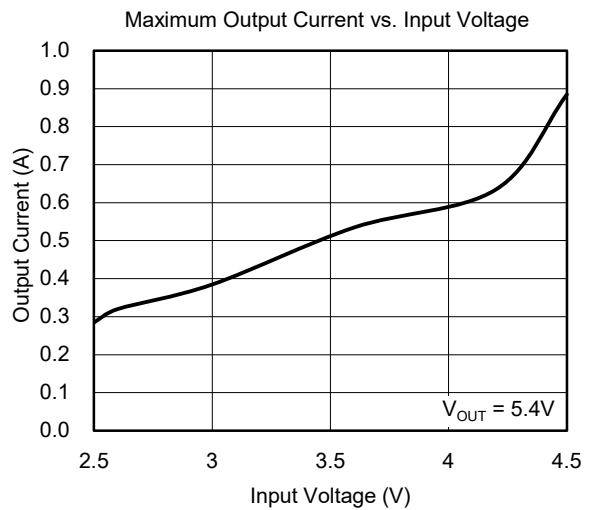
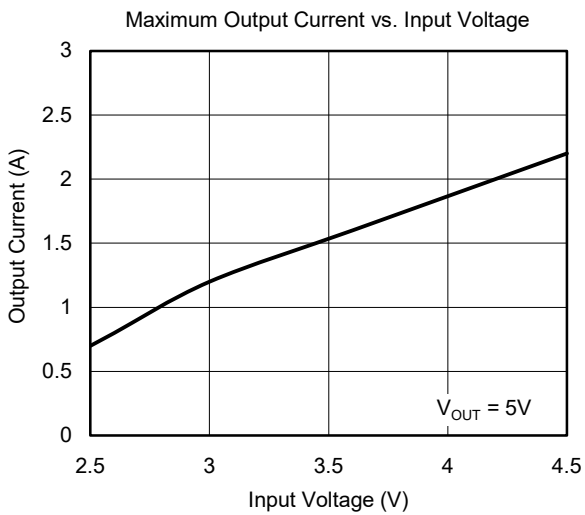
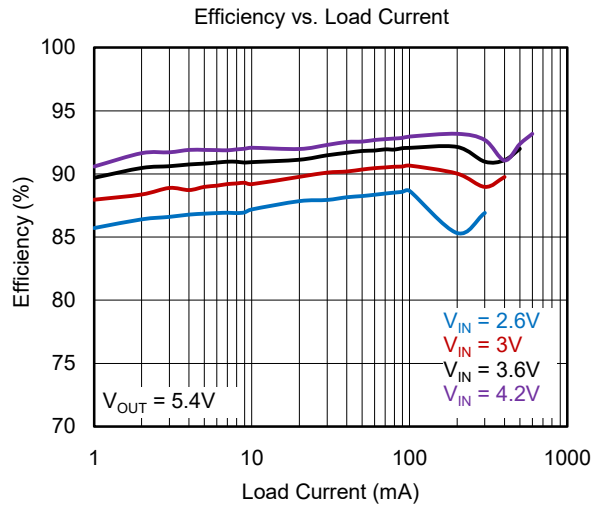
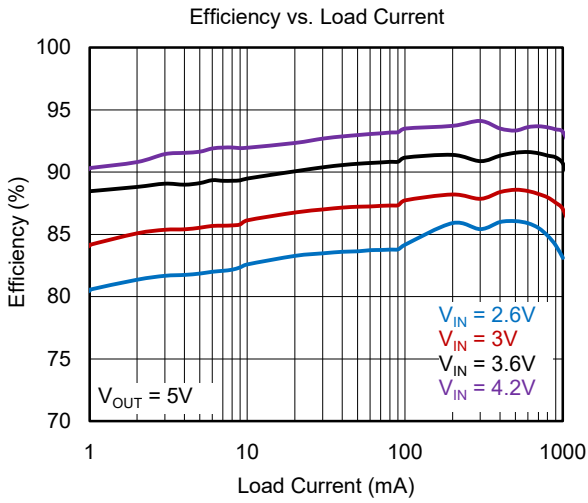

FUNCTIONAL BLOCK DIAGRAM

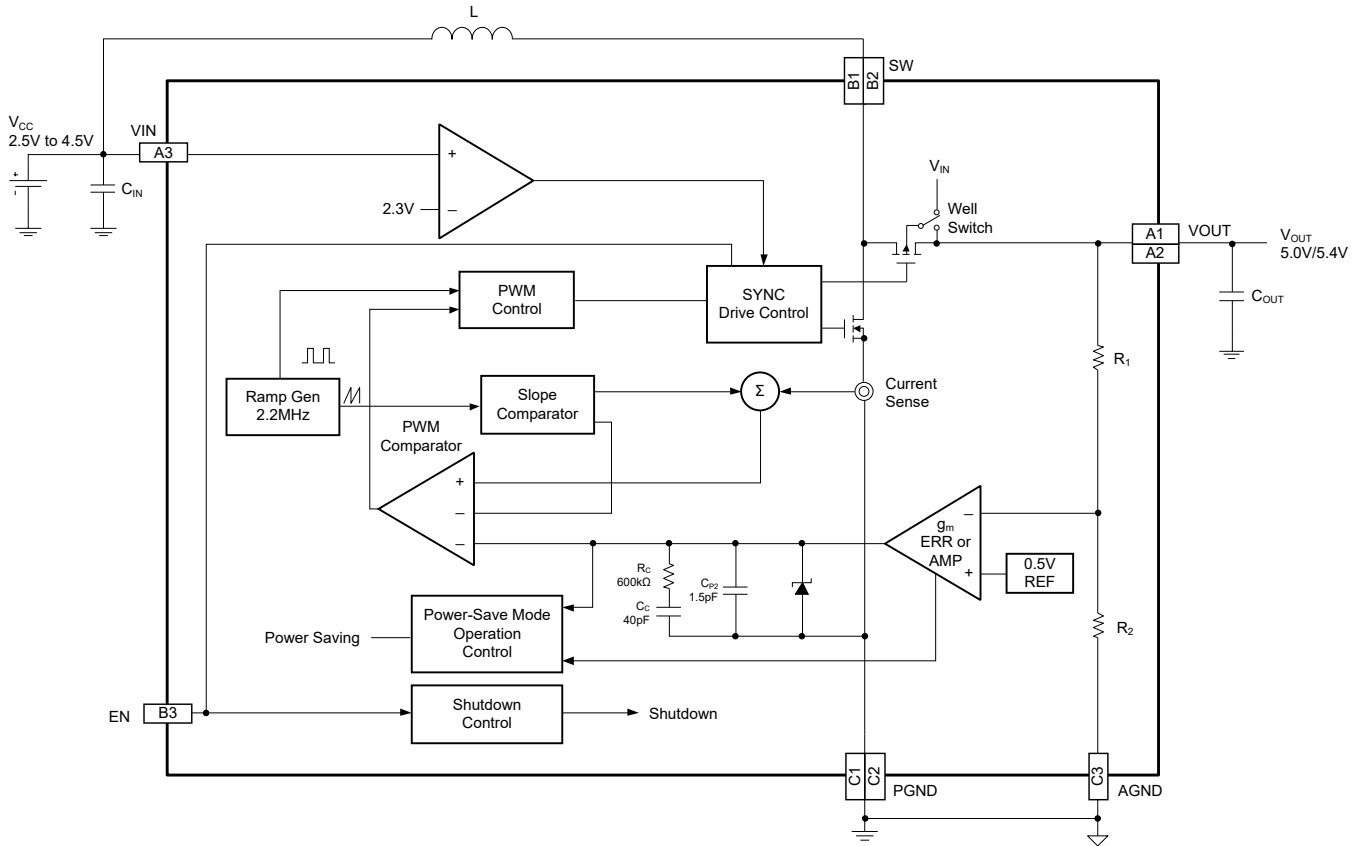

Figure 2. Block Diagram

APPLICATION INFORMATION

The SGM66055A is a boost DC/DC converter operating in 2.5V to 4.5V supply range, for generating a regulated output voltage which can be set to as low as 10% above the supply voltage. An inductor, an output storage capacitor and an input decoupling capacitor should be selected to ensure proper performance desired in a specific application circuit.

Inductor Selection

Inductor is an essential element for current DC/DC switch mode power supplies regardless of topology. Inductor serves as the energy storage element for power conversion. Inductance and saturation current of inductor are two most important criterions for inductor selection. For general design guidance, the selected inductance should provide a peak to peak ripple current that is around 30% of the average inductor current at full load and nominal input voltage. The average inductor current for a Boost converter is the input current. Equation 1 shows the calculation of inductance selection, where f_{SW} is the switching frequency and ΔI_L is the inductor ripple current.

$$L = \frac{V_{IN} \times (V_{OUT} - V_{IN})}{\Delta I_L \times f_{SW} \times V_{OUT}} \quad (1)$$

The selected inductor should have saturation current ratings higher than the 3.0A (TYP) current limit of SGM66055A-5.0 and the 1.3A (TYP) current limit of SGM66055A-5.4.

The inductor also affects the close loop response of the DC/DC converter. The SGM66055A is an internally compensated device; the loop response is optimized for inductor in the range of 0.47 μ H and 2.2 μ H.

Input Capacitor

Boost converter's input capacitor has continuous current throughout the entire switching cycle, a 4.7 μ F ceramic capacitor is recommended to place as close as

possible between the VCC pin and GND pin of the device. For applications where the SGM66055A is located far away from the input source, a 47 μ F or higher capacitance capacitor is recommended to damp the wiring harness inductance.

Output Capacitor

The output capacitors of Boost converter dictate the output voltage ripple and load transient response. Equation 2 is used to estimate the necessary capacitance to achieve desired output voltage ripple, where ΔV is the maximum allowed ripple.

$$C_{MIN} = \frac{I_{OUT} \times (V_{OUT} - V_{IN})}{f_{SW} \times \Delta V \times V_{OUT}} \quad (2)$$

Since SGM66055A is an internally compensated device, the loop response is optimized for capacitor in the range of 10 μ F to 47 μ F. If the load current is larger than 300mA, a minimum value of 22 μ F is recommended. Due to the DC bias nature of ceramic capacitors, care should be taken by verifying manufacture's datasheet to ensure enough effective capacitance at desired output voltage.

Layout Considerations

In addition to component selection, layout is a critical step to ensure the performance of any switch mode power supplies. Poor layout could result in system instability, EMI failure, and device damage. Thus, place the inductor, input and output capacitors as close to the IC as possible, and use wide and short traces for current carrying traces to minimize PCB inductance.

For Boost converter, the current loop of the output capacitor from VOUT pin back to the PGND pin of the device should be as small as possible.

REVISION HISTORY

NOTE: Page numbers for previous revisions may differ from page numbers in the current version.

APRIL 2022 – REV.A.2 to REV.A.3	Page
Updated Application section	10

MAY 2019 – REV.A.1 to REV.A.2	Page
Updated SGM66055A-5.4	4, 5, 7, 8

FEBRUARY 2019 – REV.A to REV.A.1	Page
Updated Features	1

Changes from Original (AUGUST 2018) to REV.A	Page
Changed from product preview to production data	All

PACKAGE OUTLINE DIMENSIONS

WLCSP-1.21×1.21-9B

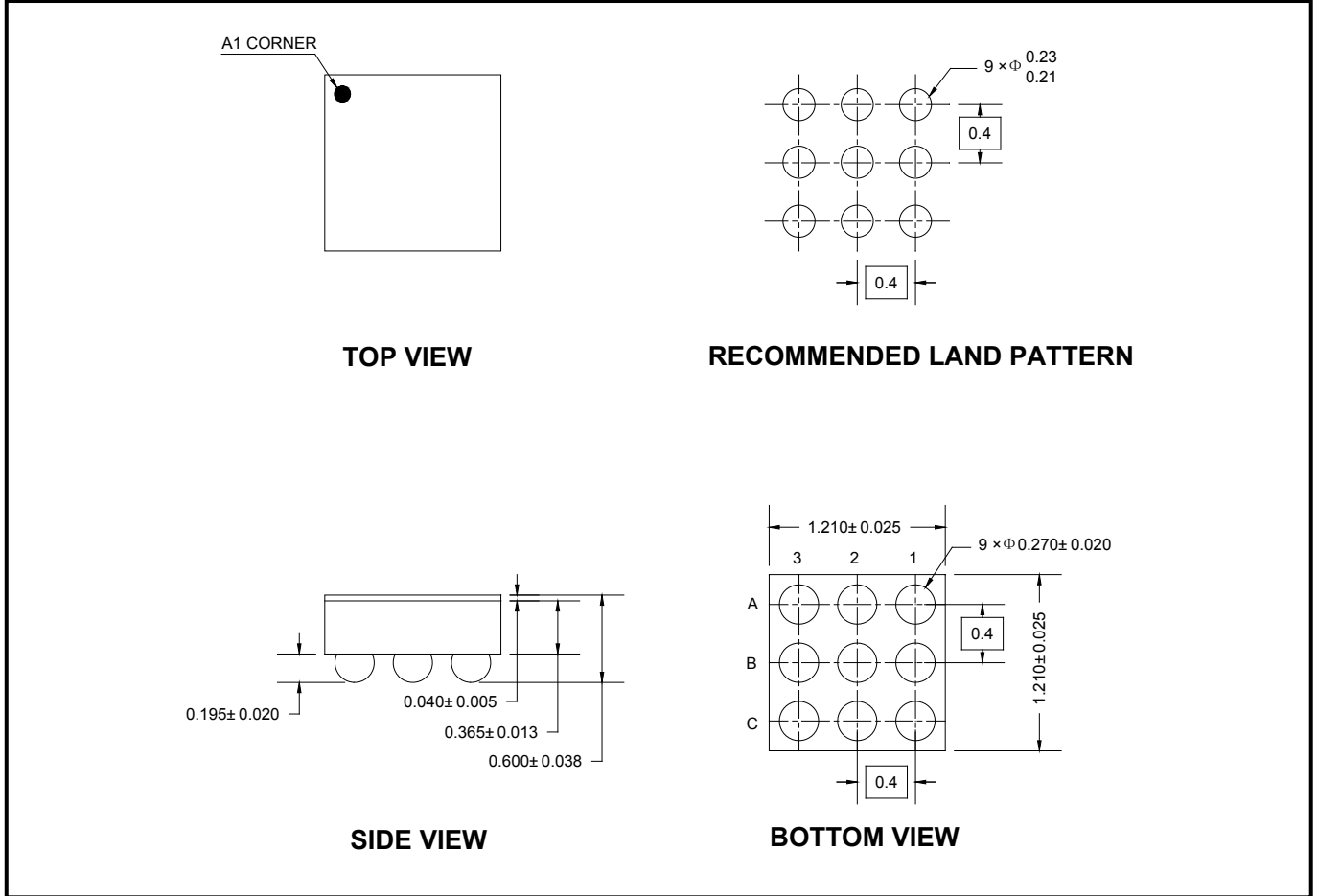

NOTE: All linear dimensions are in millimeters.

PACKAGE INFORMATION

TAPE AND REEL INFORMATION

REEL DIMENSIONS



TAPE DIMENSIONS



NOTE: The picture is only for reference. Please make the object as the standard.

KEY PARAMETER LIST OF TAPE AND REEL

Package Type	Reel Diameter	Reel Width W1 (mm)	A0 (mm)	B0 (mm)	K0 (mm)	P0 (mm)	P1 (mm)	P2 (mm)	W (mm)	Pin1 Quadrant
WLCSP-1.21×1.21-9B	7"	9.2	1.33	1.33	0.74	4.0	4.0	2.0	8.0	Q1

000001

PACKAGE INFORMATION

CARTON BOX DIMENSIONS



NOTE: The picture is only for reference. Please make the object as the standard.

KEY PARAMETER LIST OF CARTON BOX

Reel Type	Length (mm)	Width (mm)	Height (mm)	Pizza/Carton
7" (Option)	368	227	224	8
7"	442	410	224	18

DD0002